

SAVOY HOUSE

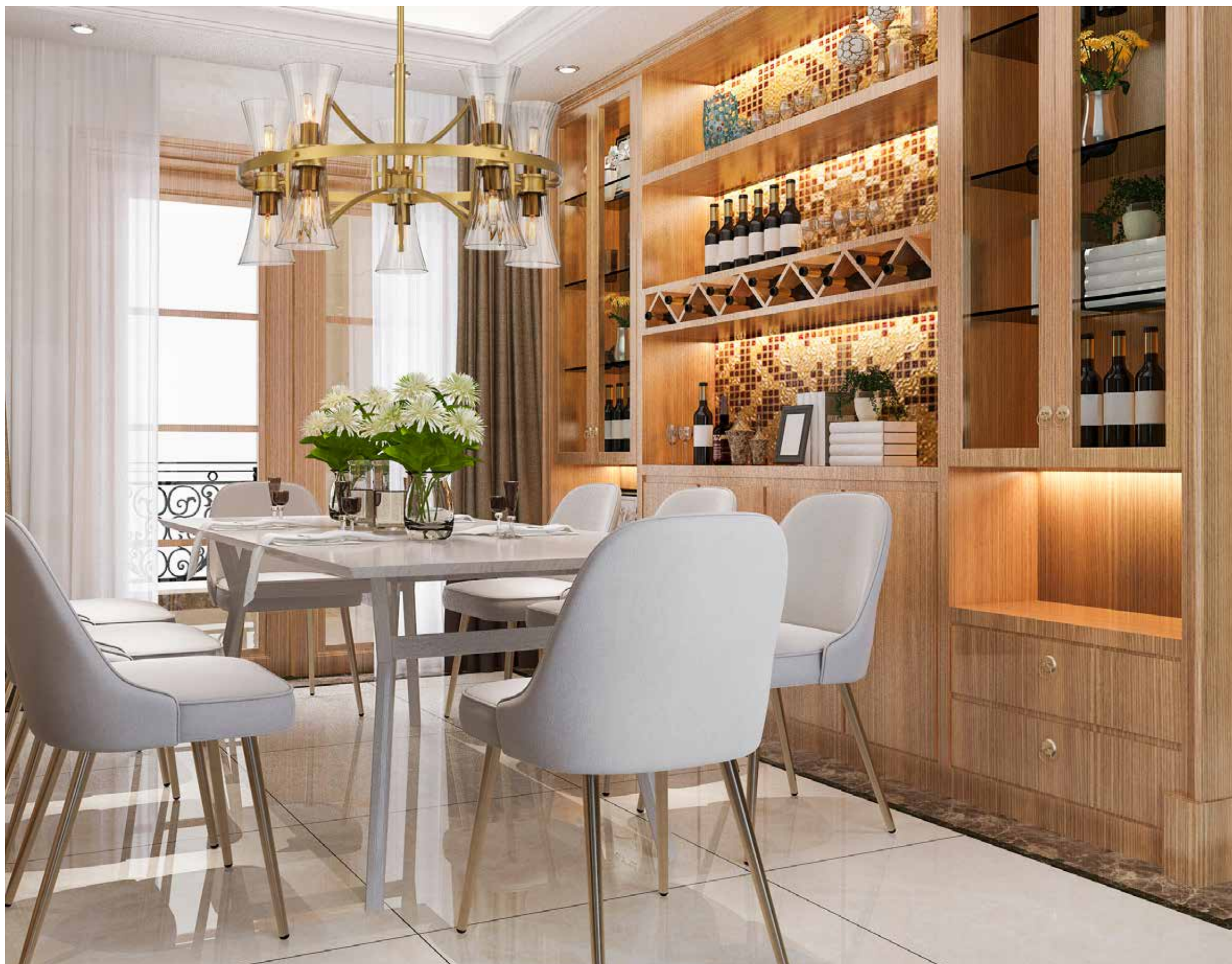

LIGHTING CATALOG
2023



As a leader in the lighting industry, Savoy House is proudly featured in premium showrooms and retailers across the United States.

Since 1965, we have been an attainable luxury lighting brand with stellar customer service. Our commitment to quality and style makes us the go-to choice for interior designers, builders and lighting enthusiasts alike.

Our 2023 catalog showcases our selection of premier lighting designs, from chandeliers and bath lights to pendants and outdoor lanterns. You will find a wonderful selection of styles, sizes and finishes to fit any space. We are delighted to bring you our elevated lighting looks and we thank you for being a part of our continued growth.

CONTENTS

ALPHABETICAL LISTING BY FAMILY:















INTERIOR

Abel106, 275, 288	Chaucer188	Hayward . .100, 102, 274	Pearl190
Adams40, 282	Claiborne64	Hayward318	Perignon266
Albany306	Clayton275	Helen6	Poppy298
Alberta261	Colt304	Hudson46	Portia70, 246, 272
Alberti106	Contessa162	Inman320	Pulaski182, 256
Alvara260	Corning222, 269	Iris42	Pyramid72
Amani158, 160	Couplet . .166, 250, 271	Jaylar277, 295	Quatrain . .36, 254, 272
Anholt52	Cyperas138	Joliet176	Quincy34, 273
Archway .168, 250, 273	Dahlia28, 272	Kahn86, 271	Radcliffe204
Ariel164	Daintree62	Kameron198	Redmond309
Aries108	Daniels134, 136	Kearney128, 275	Rochester230
Arlon18	Darby280	Kellerman122	Rory90
Ashbourne258	Dauphin318	Kelvin125	Rosendal273
Ashburn142	Deandre202	Kian123	Rotterdam30
Ashe144, 253	Delphi120, 249	Kirkland126	Salem178
Ashor104, 246	Dexter172	Kirsch124, 274	Santiago208
Astoria . .146, 148, 253	Director212	Lamar220	Seneca237
Azores78, 80	Dryden . . .84, 206, 273	Lambert311	Scout319
Baguette44	Dunbar274	Landon68	Shelby228
Bali174	Eaton . . .116, 290, 274	Lansing315	Shellbourne10, 273
Beacon156, 272	Eaton318	Laramie180, 226	Shields214
Bennington14, 278	Eclipse118, 245	Lenox232	Sidney284
Bennington272	Eden322	Livorno54, 242	Sommerton224
Bergamo66	Edina76, 248	Lorraine276	Southerby276
Birch130	Eman150	Luna58, 242	Sullivan32, 272
Birone303	Emerald45	Macauley 274, 294, 364	Talbot238
Biscayne . . .88, 255, 271	Ericson360	Macra154	Tartan236
Boca82	Florasian152	Madera . . .50, 257, 277	Tivoli110, 244, 275
Bozeman184, 186	Folsom173, 262	Mallory192	Tulsa262
Brannon310	Fulton274	Marquise74	Tyanna94, 257
Breur292	Gavin216, 268, 316	Mayfair4	Vasare92
Brickell286	Gideon . .20, 22, 24, 234	Midland . .114, 244, 275	Vaughan308
Burgess . .196, 256, 314	Gideon254, 271	Moreno300	Ventura96, 98
Burnham56	Glenwood48, 319	Nouvel16	Victor277
Byron8	Halifax312	Oakmont132	Vista200
Camille26	Hampton302	Oberon276	Wheaton264
Cannon141	Hartberg324, 326	Oberyn275	Windham60
Capella112, 248	Hartford263	Orion210	Windsung239
Carlysle218	Hasting194, 255	Orleans13	Woodbury296
Charter140	Haven170, 247, 273	Pampas155	Wynwood38

OUTDOOR

Barrett378
Belmont376
Boone332
Brennan362
Brooke358
Brookline334
Dansk376
Denver338
Dunmore350
Dunston376
Ellijay344, 346
Hamilton361
Hancock348
Jackson342
Kensington378
Kingsley330
Lauren356
Macauley364
Mica376
Millford336
Milton354
Monte Grande352
Monticello372, 374
Montpelier328
Palmer366
Parker368
Raleigh376
Scout378
Taylor370
Woodstock340

CONTENTS

	Neo-Traditional4
	Renaissance Guild52
	Today's Classic Style96
	Lighting Organics130
	Mid-Century156
	Casual Sophistication174
	Architectural198
	Pendants / Lanterns216
	Linear Lighting242
	Wall Lighting258
	Pour Le Bain / Vanity / Glass278
	Ceiling316
	Garden Chandeliers320
	Outdoor328

Stem Info / Finish Guide / Index	382
--	-----

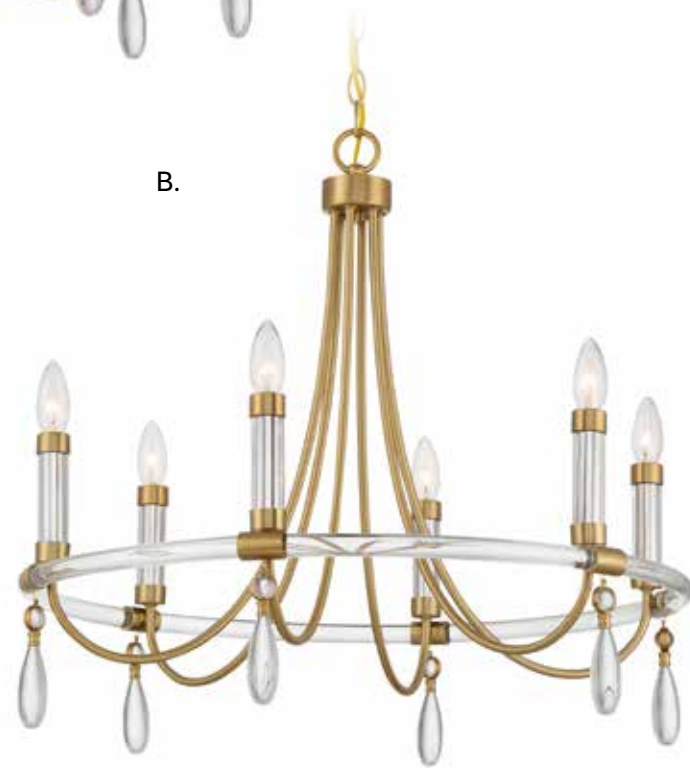

A. 1-7718-8-195
 8-Light Chandelier
 Warm Brass w/
 Chrome Finish
 30"W x 27"H
 8C 60W
 Clear Acrylic
 Clear Crystal

B. 1-7716-6-195
 6-Light Chandelier
 Warm Brass w/
 Chrome Finish
 25-1/2"W x 23-1/2"H
 6C 60W
 Clear Acrylic
 Clear Crystal

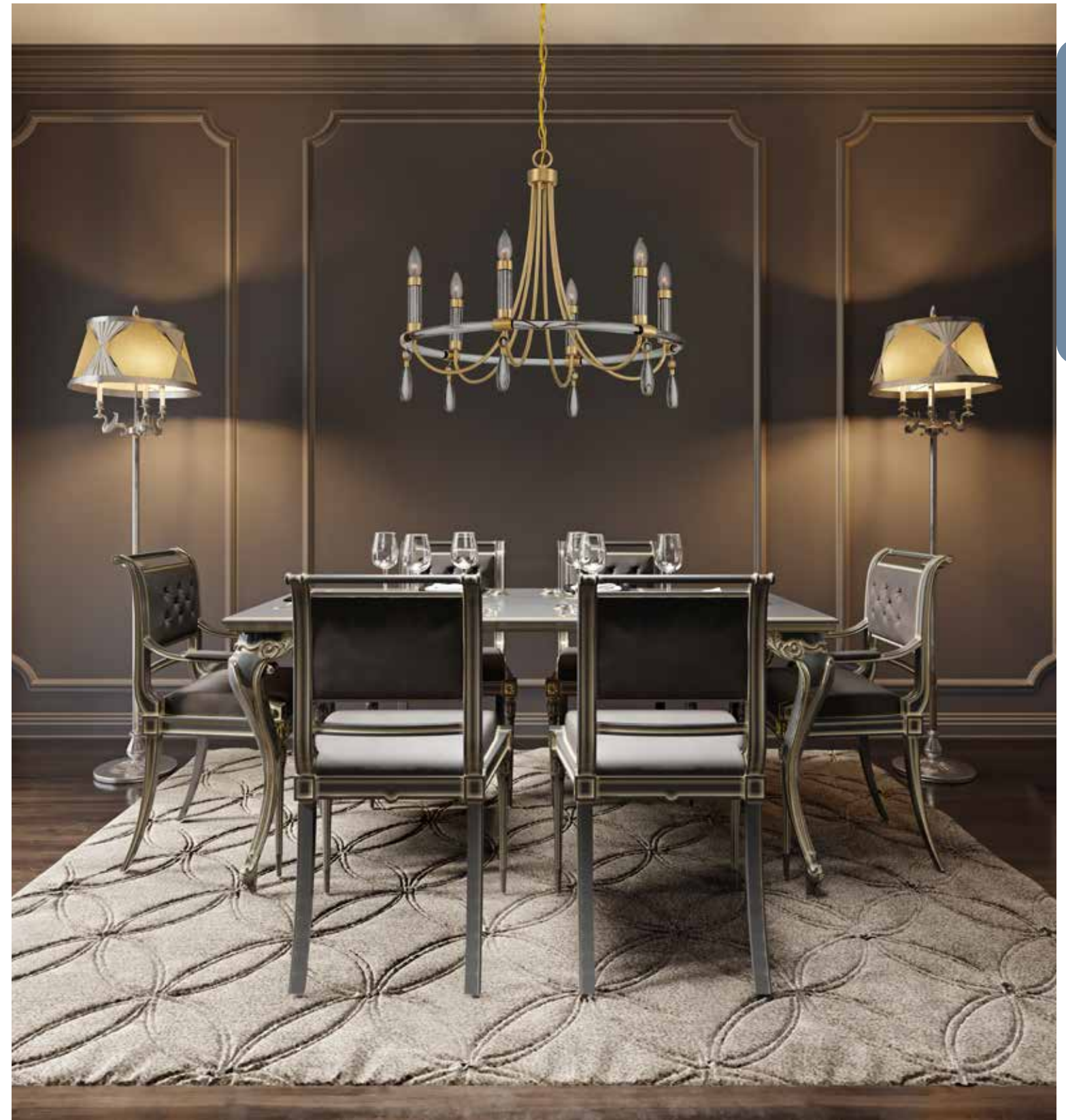

Includes 120" chain & wire



*A.

A. 1-8803-5-322
 5-Light Chandelier
 Warm Brass Finish
 27"W x 26-1/4"H
 Adj H 26-1/4" - 80-1/4"
 5C 60W
 Frosted Glass Accents

B. 1-8804-8-322
 8-Light Chandelier
 Warm Brass Finish
 32"W x 31-3/4"H
 Adj H 31-3/4" - 85-3/4"
 8C 60W
 Frosted Glass Accents



**B.



Dual Mount Hanging System

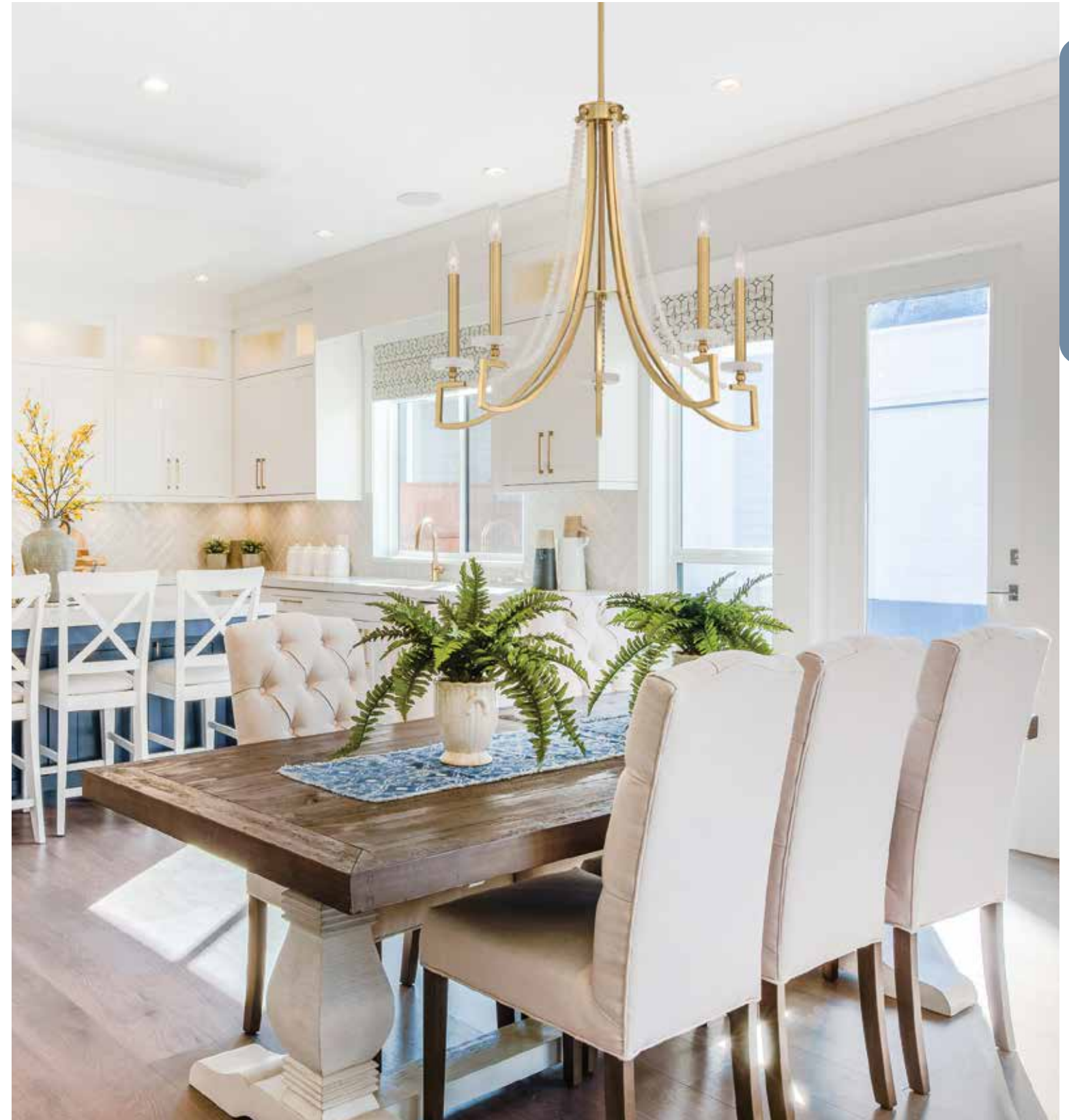

*Includes 12" & 6" extensions - additional stems available - 7-EXT

**Includes 12" & 6" extensions - additional stems available - 7-EXTLG



Includes 120" chain & wire



A.

A. 7-3362-6-322
 6-Light Pendant
 Warm Brass Finish
 16"W x 34-1/2"H
 6C 60W
 Frosted Glass



B.

B. 1-3364-6-322
 6-Light Chandelier
 Warm Brass Finish
 24"W x 29"H
 6C 60W
 Frosted Glass

SHELLBOURNE

NEO-TRADITIONAL



*Includes 12" & 6" extensions - additional stems available - 7-EXT

SHELLBOURNE

NEO-TRADITIONAL



Dual Mount Hanging System

A. 1-2106-5-322
 5-Light Chandelier
 Warm Brass Finish
 26"W x 14"H
 Adj H 14" - 68"
 5C 60W
 Handmade Piastra Glass

B. 9-2104-1-322
 1-Light Sconce
 Warm Brass Finish
 5"W x 16-1/2"H x 6-1/2"E
 1C 60W
 Handmade Piastra Glass

B.



ORLEANS

NEO-TRADITIONAL

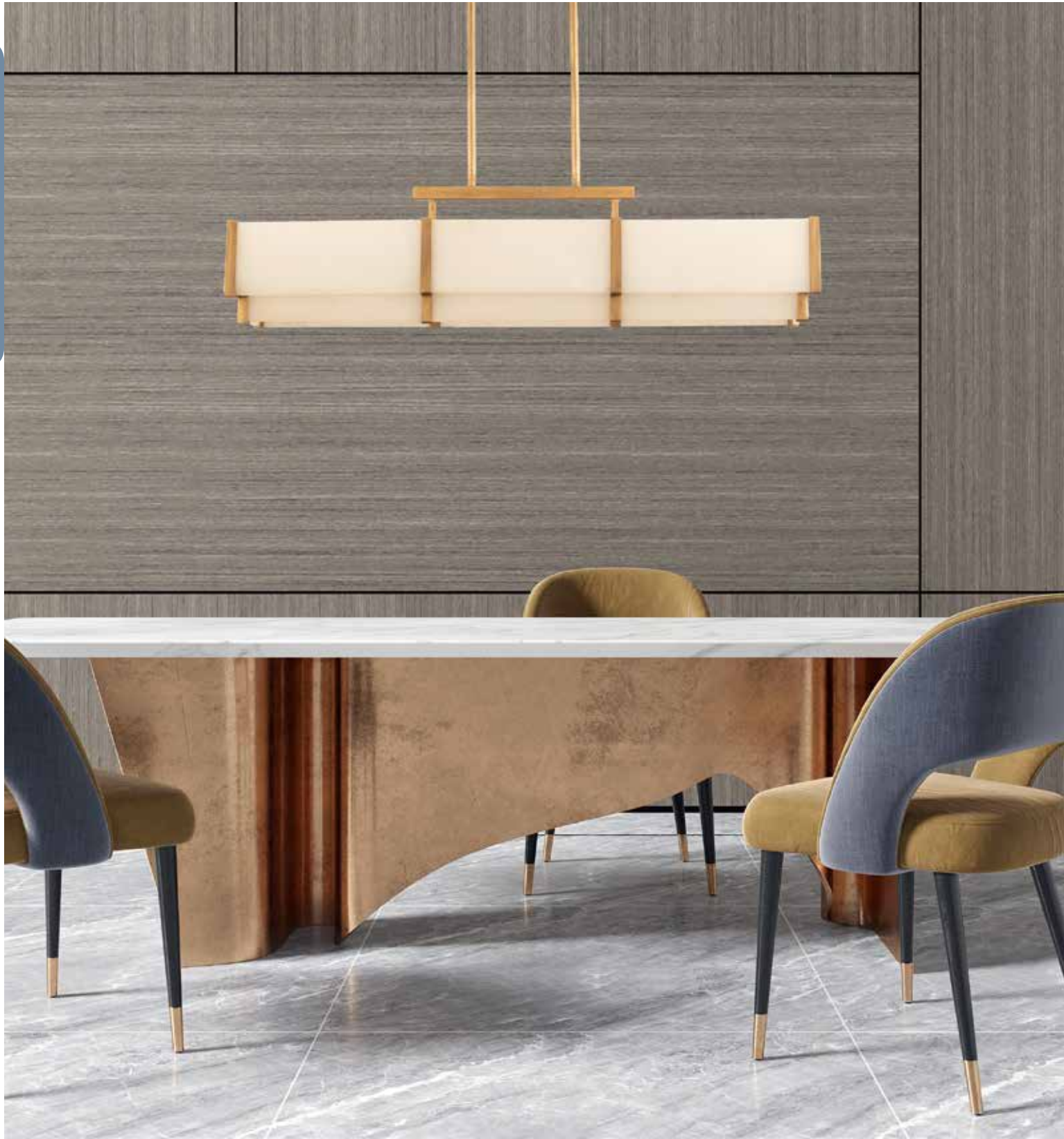

*Includes 120" chain & wire

**Includes 12" & 6" extensions - additional stems available - 7-EXTLG

ORLEANS

NEO-TRADITIONAL

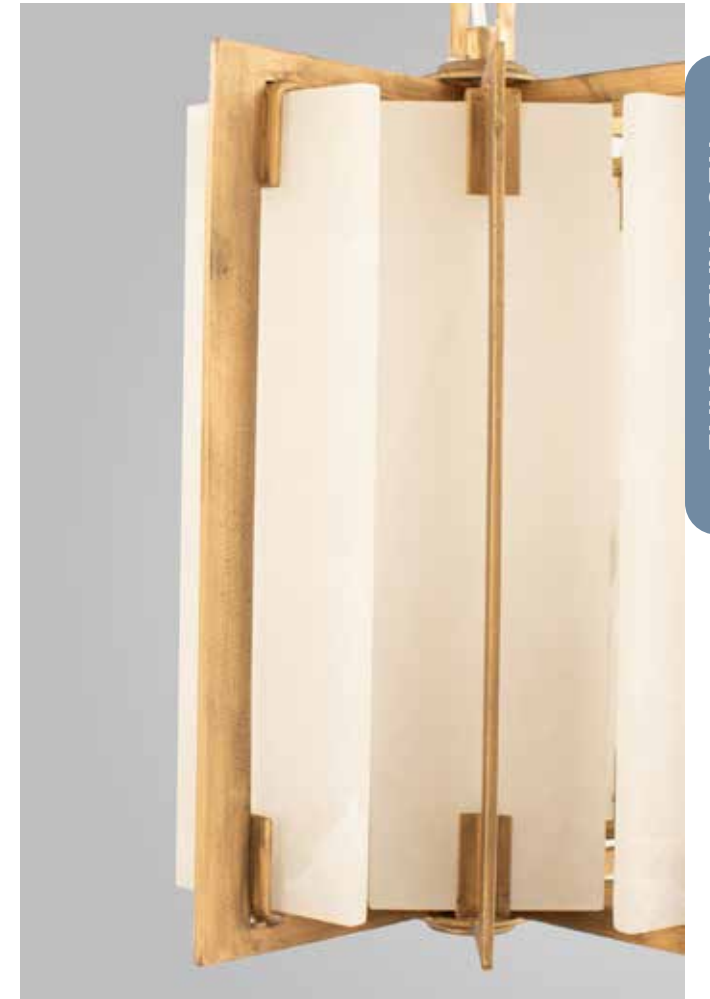

*A.



A. 7-2331-4-60
4-Light Pendant
Distressed Gold Finish
12-1/4"W x 16"H
4C 60W
Natural Alabaster Stone

B. 1-2330-5-60
5-Light Linear Chandelier
Distressed Gold Finish
8"W x 11"H x 44-1/2"L
Adj H 11" - 65"
5C 60W
Natural Alabaster Stone

**B.



Dual Mount Hanging System





Dual Mount Hanging System



A.

- A. 1-9705-16-322**
16-Light Chandelier
Warm Brass Finish
45"W x 24"H
Adj H 24" - 78"
16C 60W
Clear Ribbed Glass



B.

- B. 1-9704-10-322**
10-Light Chandelier
Warm Brass Finish
30-1/2"W x 18"H
Adj H 18" - 72"
10C 60W
Clear Ribbed Glass

Includes 12" & 6" extensions - additional stems available - 7-EXTLG



Pendant, Page 235



Bath, Page 278



Sconce, Page 272, 278



Includes 12" & 6" extensions - additional stems available - 7-EXT





A. 7-1732-10-322
 10-Light Pendant
 Warm Brass Finish
 26"W x 23"H
 Adj H 23" - 77"
 2.5W Integrated Dimmable LED
 800 Lumens, 3000K, 90+CRI
 Bubble Glass

B. 1-1733-12-322
 12-Light Chandelier
 Warm Brass Finish
 38"L x 20"W x 26"H
 Adj H 26" - 80"
 2.5W Integrated Dimmable LED
 950 Lumens, 3000K, 90+CRI
 Bubble Glass

C. 1-1734-24-322
 24-Light Chandelier
 Warm Brass Finish
 44"W x 36"H
 Adj H 36" - 90"
 2.5W Integrated Dimmable LED
 1950 Lumens, 3000K, 90+CRI
 Bubble Glass

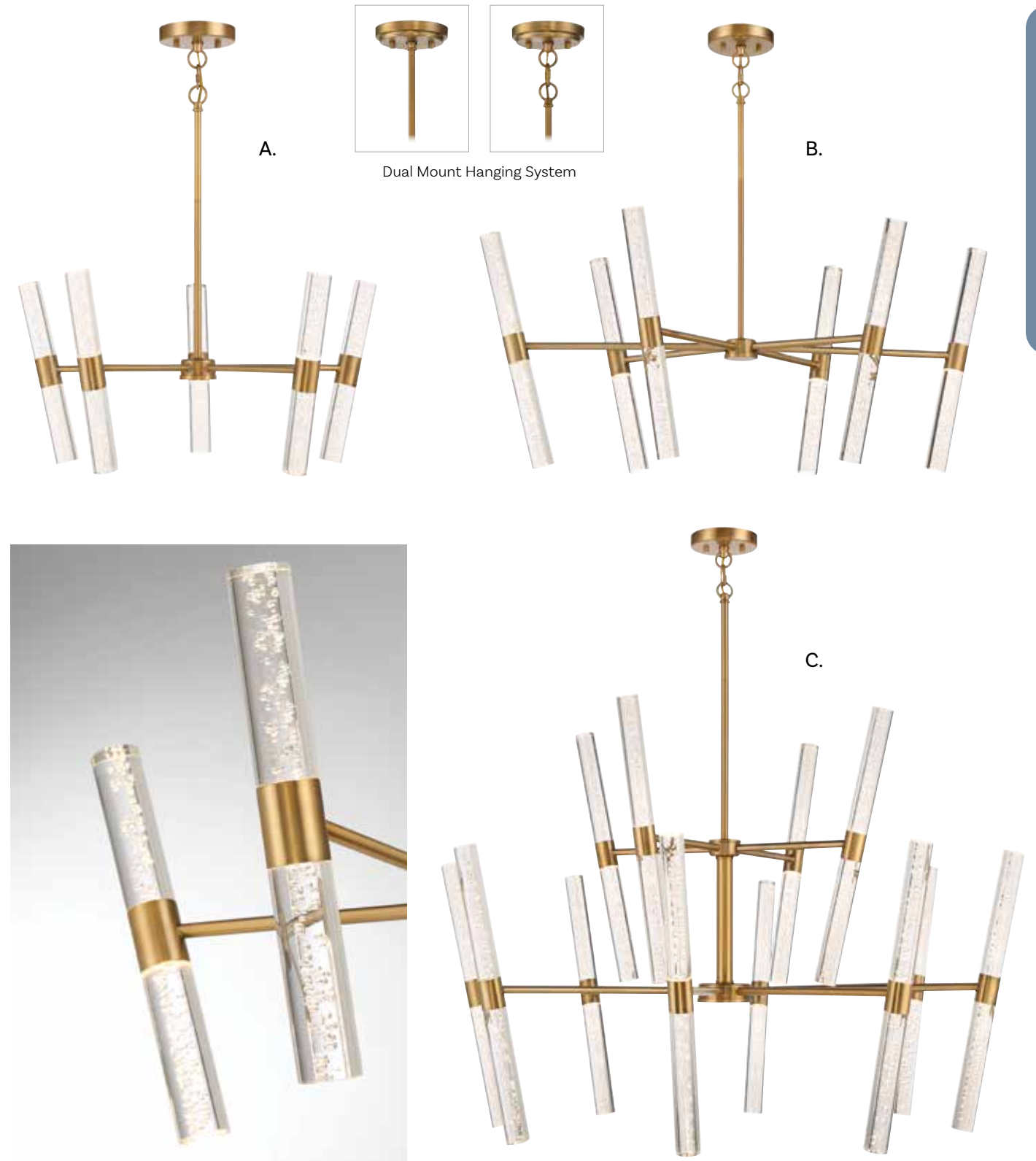

Includes 12" & 6" extensions - additional stems available - 7-EXT

*A.

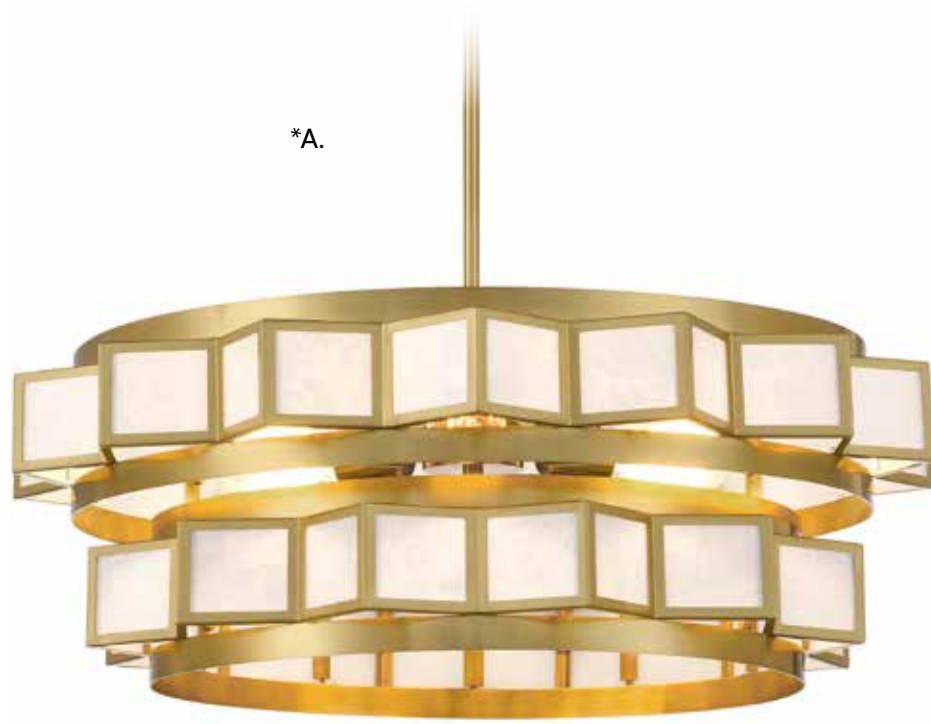

Dual Mount Hanging System

- A. 1-3166-6-322**
6-Light Chandelier
Warm Brass Finish
29"W x 10"H
Adj H 10" - 64"
6E 60W
Capiz Shell
- B. 1-3165-8-322**
8-Light Linear Chandelier
Warm Brass Finish
14-1/2"W x 5-1/4"H x 47-3/4" L
Adj H 5-1/4" - 59-1/4"
8C 60W
Capiz Shell

**B.

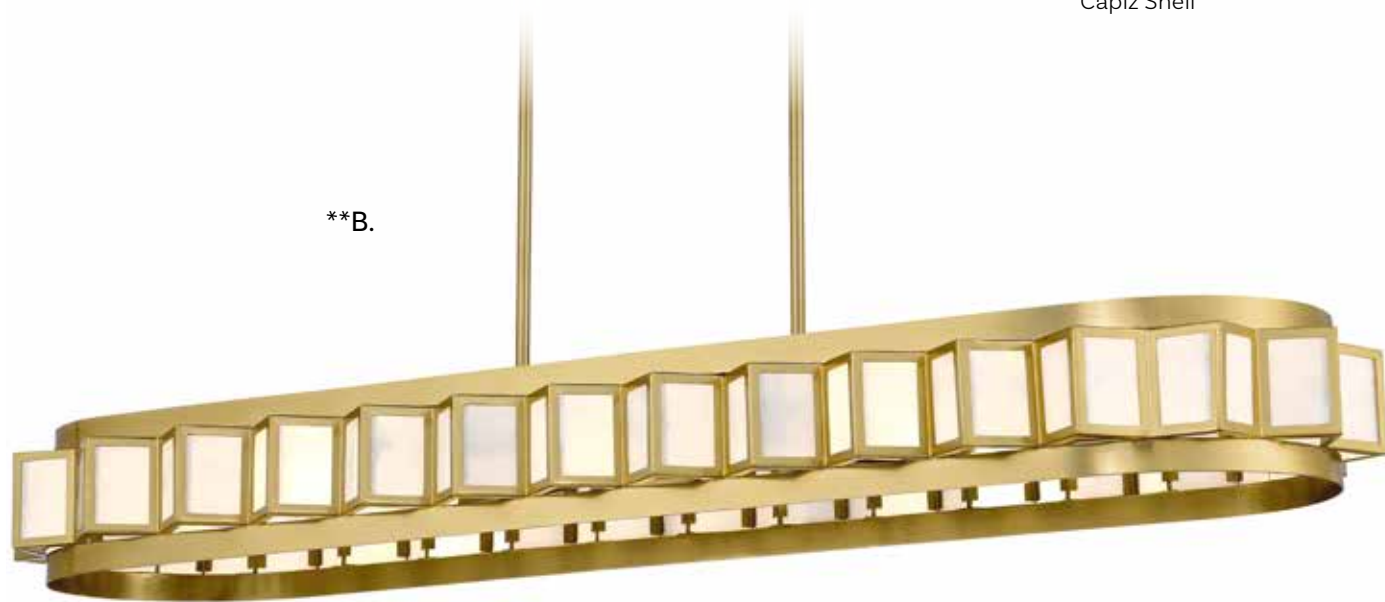

*Includes 12" & 6" extensions - additional stems available - 7-EXTLG
**Includes 12" & 6" extensions - additional stems available - 7-EXT



*Includes 12" & 6" extensions - additional stems available - **7-EXTLG**
 Includes 12" & 6" extensions - additional stems available - **7-EXT

*A.



Dual Mount Hanging System

B.



Wall Sconce

A. 7-3168-3-322
 3-Light Pendant
 Warm Brass Finish
 16"W x 17-1/2"H
 Adj H 17-1/2" - 71-1/2"
 3C 60W
 Capiz Shell

B. 9-3164-2-322
 2-Light Sconce
 Warm Brass Finish
 10"W x 11"H x 4-1/2" E
 2C 60W
 Capiz Shell

C. 1-3167-4-322
 4-Light Chandelier
 Warm Brass Finish
 24"W x 5"H
 Adj H 5" - 59"
 4E 60W
 Capiz Shell

**C.

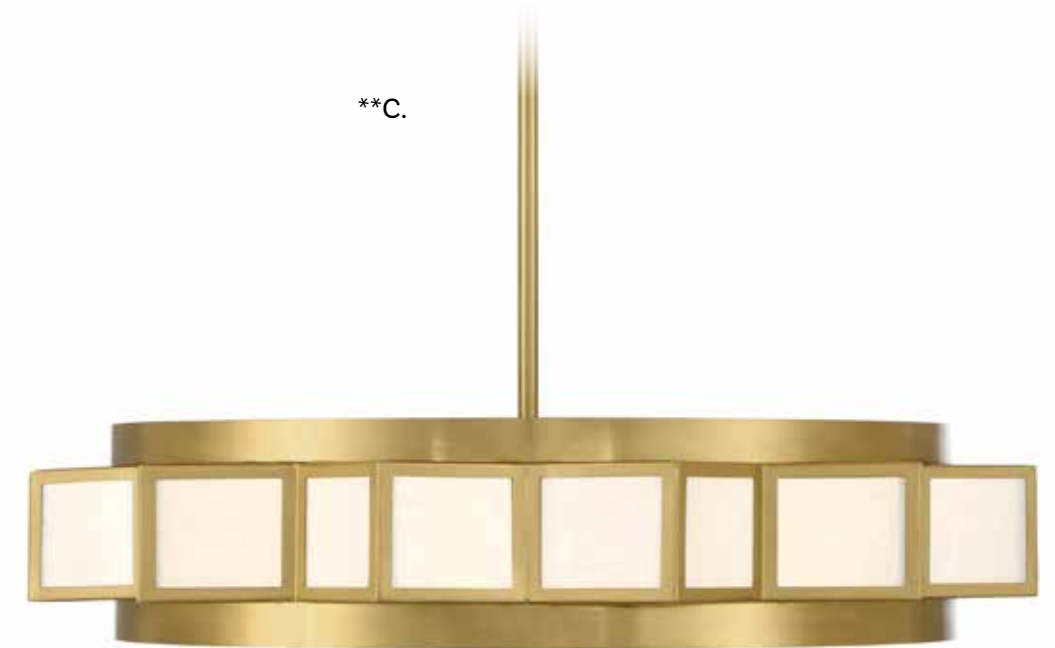



FAN NUMBER	28-FD-690-322
MOTOR FINISH	Warm Brass
BLADE FINISH	Gold
SHADE FINISH	Capiz Shell

ENERGY USE AT HIGH SPEED		
Airflow Use	Electricity Use	Airflow Efficiency
922	25W	36.88
Cu Ft/Min	Excludes Lights	Cu Ft/Min/W

Compare: 36" to 48" ceiling fans have airflow efficiencies ranging from approximately 71 to 86 cu. ft. per min. per watt at high speed.

- Motor Size 104-1/2 x 111
- 14" Blade Span
- 23"W x 15-1/2"H (Cage Only)
- 13° Blade Pitch
- Downrods Included 18" & 4"
- Additional Downrod Lengths Sold Separately
- 4E 6W Dimmable LED
- 2000 Lumens, 3000K, 90+ CRI
- Not Hugger Kit Adaptable
- Handheld Remote Included (RMT-AC-UNIVERSAL)
- UL Damp Location
- Lamp Included



Handheld Remote Control Included
RMT-AC-UNIVERSAL



CAMILLE

CAMILLE

NEO-TRADITIONAL



1-1727-5-322
5-Light Chandelier
Warm Brass Finish
24"W x 24"H
5C 60W
Clear Glass Flowers



Includes 120" chain & wire

NEO-TRADITIONAL





A.



A. 9-4364-1-322
 1-Light Scionce
 Warm Brass Finish
 9"W x 9-1/4"H x 5" E
 1C 60W
 White Fabric Shade
 Clear Crystal

*B.



B. 7-4366-4-322
 4-Light Pendant
 Warm Brass Finish
 21"W x 14"H
 4C 60W
 White Fabric Shade
 Clear Crystal

*C.



C. 7-4368-6-322
 6-Light Pendant
 Warm Brass Finish
 30"W x 16-1/2"H
 6C 60W
 White Fabric Shade
 Clear Crystal

*Includes 120" chain & wire

ROTTERDAM

NEO-TRADITIONAL



*Includes 12" & 6" extensions - additional stems available - **7-EXTLG**

Includes 12" & 6" extensions - additional stems available - **7-EXT

The rings of the Rotterdam Collection are adjustable and can rotate into different positions.

ROTTERDAM

NEO-TRADITIONAL

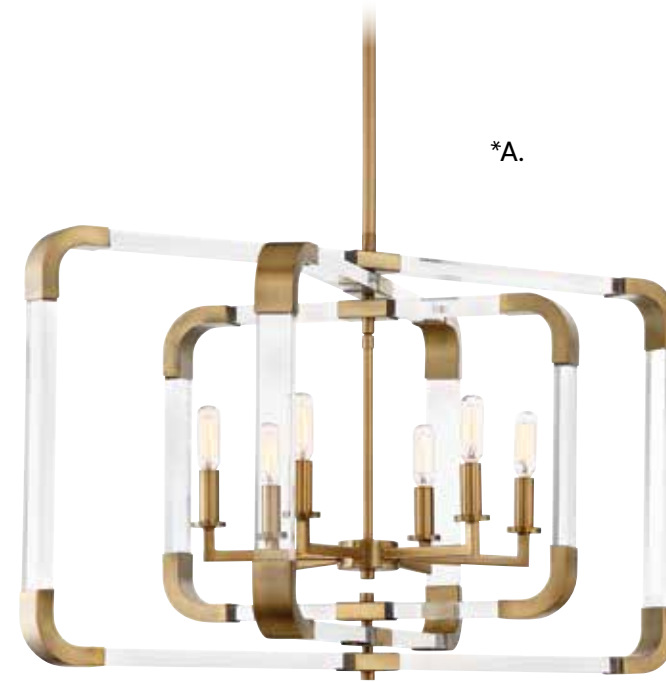

*A.



Convertible: Semi-Flush/Pendant

- A. 7-1660-6-322**
 6-Light Pendant
 Warm Brass Finish
 31-1/2"L x 24-3/4"W x 20-1/2"H
 Adj H 20-1/2" - 74-1/2"
 6C 60W
 30° Swivel
 Optic Acrylic
 Metal Candle Covers

- B. 6-1662-4-322**
 4-Light Convertible
 Semi-Flush/Pendant
 Warm Brass Finish
 20"W x 18"H
 Adj H 18" - 72"
 4C 60W
 30° Swivel
 Optic Acrylic
 Metal Candle Covers



**B.

BRIAN THOMAS
 COLLECTION



A.



*B.

A. 9-2204-2-322
2-Light Wall Sconce
Warm Brass Finish
10"W x 9"H x 5"E
2C 60W

B. 1-2206-8-322
8-Light Chandelier
Warm Brass Finish
32"W x 27-1/4"H
8C 60W

C. 1-2208-10-322
10-Light Chandelier
Warm Brass Finish
40"W x 35-1/2"H
10C 60W



*C.

*Includes 120" chain & wire

NEO-TRADITIONAL

NEO-TRADITIONAL

*A.



B.



A. 1-9945-5-143
 5-Light Chandelier
 Warm Brass w/ Matte Black Finish
 27"W x 14-1/4"H
 Adj H 14-1/4" - 68-1/4"
 5C 60W
 Metal Shade

B. 9-9944-1-143
 1-Light Sconce
 Warm Brass w/ Matte Black Finish
 5-1/4"W x 18-1/2"H x 7"E
 1C 60W
 Metal Shade



Dual Mount Hanging System

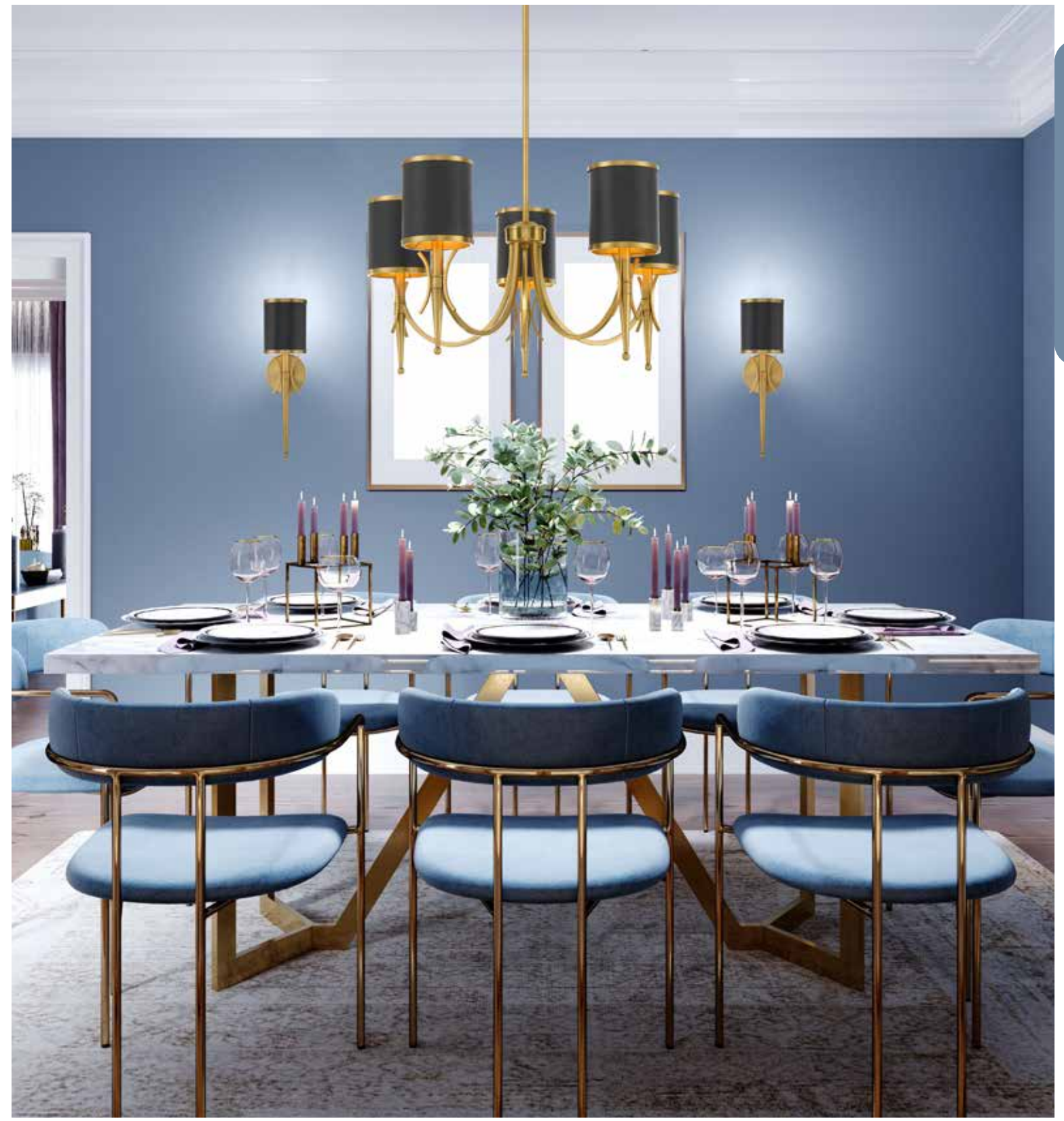

*Includes 12" & 6" extensions - additional stems available - 7-EXT

QUATRRAIN

QUATRRAIN

NEO-TRADITIONAL

NEO-TRADITIONAL



A. 7-2303-4-260
4-Light Pendant
True Gold Finish
22-3/4"W x 20"H
Adj H 20" - 74"
4E 60W
White Fabric Shade

B. 1-2304-6-260
6-Light Chandelier
True Gold Finish
30"W x 23"H
Adj H 23" - 77"
6E 60W
White Opal Glass

C. 1-2305-8-260
8-Light Linear Chandelier
True Gold Finish
15-1/2"W x 21"H x 41-1/4" L
Adj H 21" - 75"
8E 60W
White Opal Glass



Sconce, Page 272



Includes 12" & 6" extensions - additional stems available - 7-EXT



Dual Mount Hanging System

*A.



**C.



*B.



A. 1-7751-5-322
 5-Light Chandelier
 Warm Brass Finish
 24"W x 17-1/2"H
 Adj H 17-1/2" - 71-1/2"
 5C 60W
 Soft White String Shade

B. 1-7750-4-322
 4-Light Chandelier
 Warm Brass Finish
 16"W x 32"H
 Adj H 32" - 86"
 4C 60W
 Soft White String Shade

C. 1-7752-6-322
 6-Light Chandelier
 Warm Brass Finish
 30"W x 20"H
 Adj H 20" - 74"
 6C 60W
 Soft White String Shade



*Includes 12" & 6" extensions - additional stems available - 7-EXT

**Includes 12" & 6" extensions - additional stems available - 7-EXTLG



A. 9-4417-1-322
1-Light Sconce
Warm Brass Finish
7"W x 11"H x 7-1/2"E
1E 60W
White Strie Glass

B. 1-4418-3-322
3-Light Chandelier
Warm Brass Finish
21"W x 13-1/2"H
Adj H 13-1/2" - 67-1/2"
3E 60W
White Strie Glass

C. 1-4419-5-322
5-Light Chandelier
Warm Brass Finish
25"W x 14-1/2"H
Adj H 14-1/2" - 68-1/2"
5E 60W
White Strie Glass



Bath, Page 282

A.



*B.



Dual Mount Hanging System

*C.



*Includes 12" & 6" extensions - additional stems available - 7-EXT

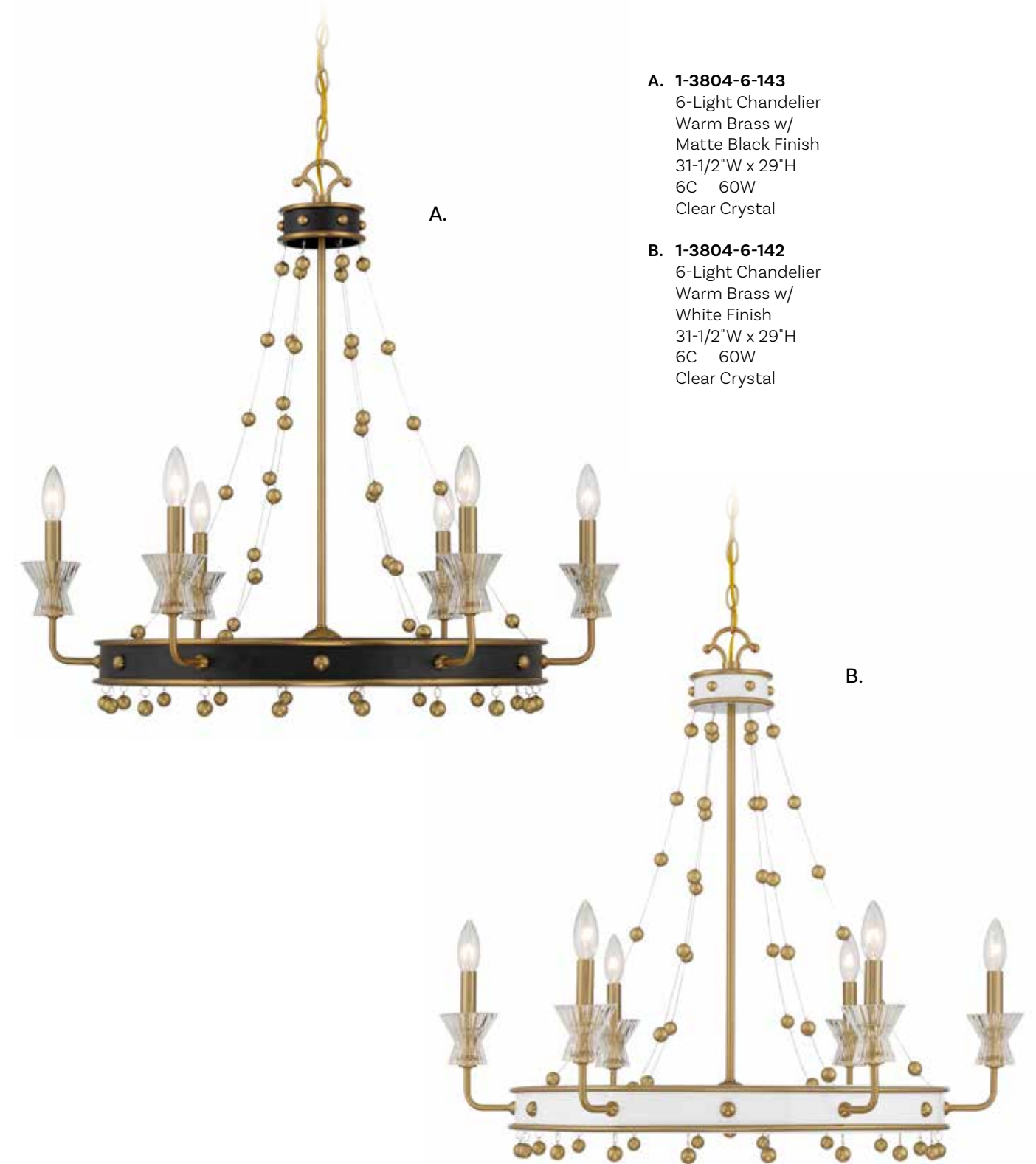

A. 1-3804-6-143
 6-Light Chandelier
 Warm Brass w/
 Matte Black Finish
 31-1/2"W x 29"H
 6C 60W
 Clear Crystal

B. 1-3804-6-142
 6-Light Chandelier
 Warm Brass w/
 White Finish
 31-1/2"W x 29"H
 6C 60W
 Clear Crystal

Includes 120" chain & wire

BAGUETTE

BAGUETTE/EMERALD

NEO-TRADITIONAL



NEO-TRADITIONAL



Includes 120" chain & wire

A. BAGUETTE
7-1871-4-322
 4-Light Pendant
 Warm Brass Finish
 20"W x 25"H
 4E 60W
 Mercury Glass

B. BAGUETTE
7-1871-4-28
 4-Light Pendant
 Oiled Burnished
 Bronze Finish
 20"W x 25"H
 4E 60W
 Dark Mercury Glass

C. EMERALD
7-1870-4-28
 4-Light Pendant
 Oiled Burnished
 Bronze Finish
 20"W x 26-1/2"H
 4E 60W
 Dark Mercury Glass

D. EMERALD
7-1870-4-322
 4-Light Pendant
 Warm Brass Finish
 20"W x 26-1/2"H
 4E 60W
 Mercury Glass



A. 1-1852-10-89
 10-Light Oval Chandelier
 Matte Black Finish
 48" L x 16" W x 24-1/2" H
 10C 60W
 Clear Water Piastra Glass
 Metal Candle Covers

B. 7-1850-8-89
 8-Light Pendant
 Matte Black Finish
 28" W x 23" H
 8C 60W
 Clear Water Piastra Glass
 Metal Candle Covers

C. 7-1851-12-89
 12-Light Pendant
 Matte Black Finish
 36" W x 31" H
 12C 60W
 Clear Water Piastra Glass
 Metal Candle Covers

B.



C.



A.

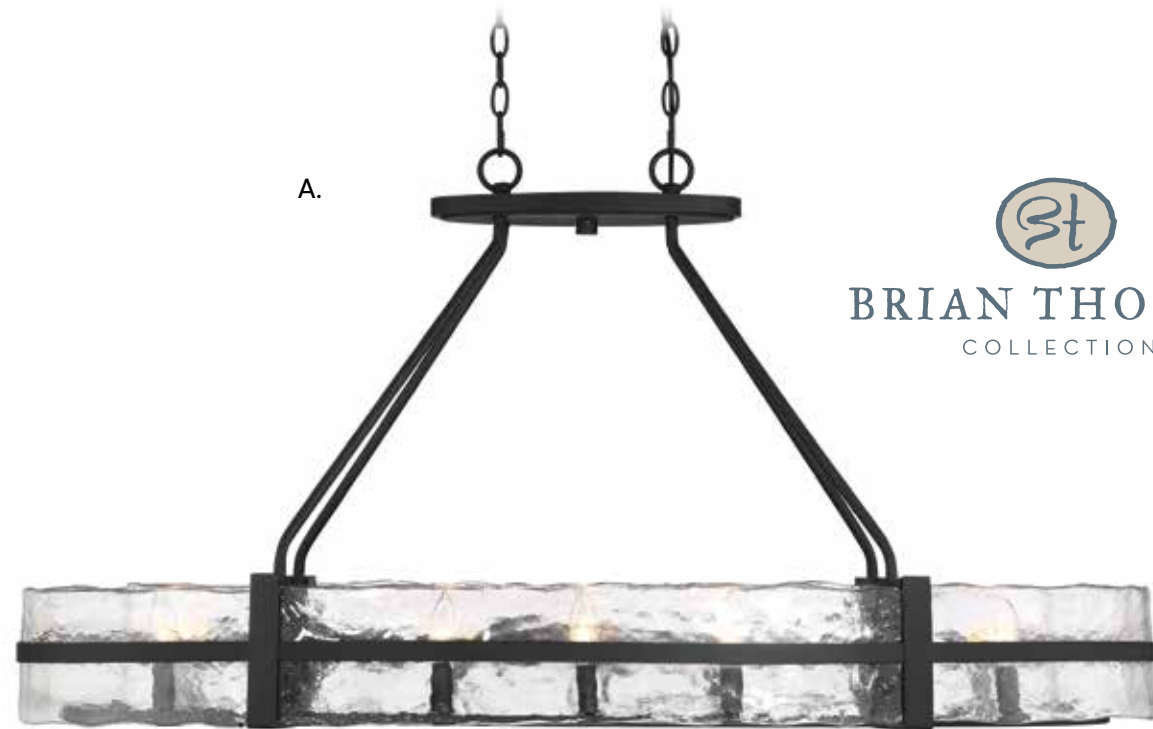

BRIAN THOMAS
 COLLECTION

Includes 120" chain & wire

GLENWOOD

NEO-TRADITIONAL



A. 1-3043-5-13
 5-Light Linear Chandelier
 English Bronze Finish
 45-1/8"L x 7"W x 30-1/4"H
 5E 60W
 Clear Water Piastra Glass

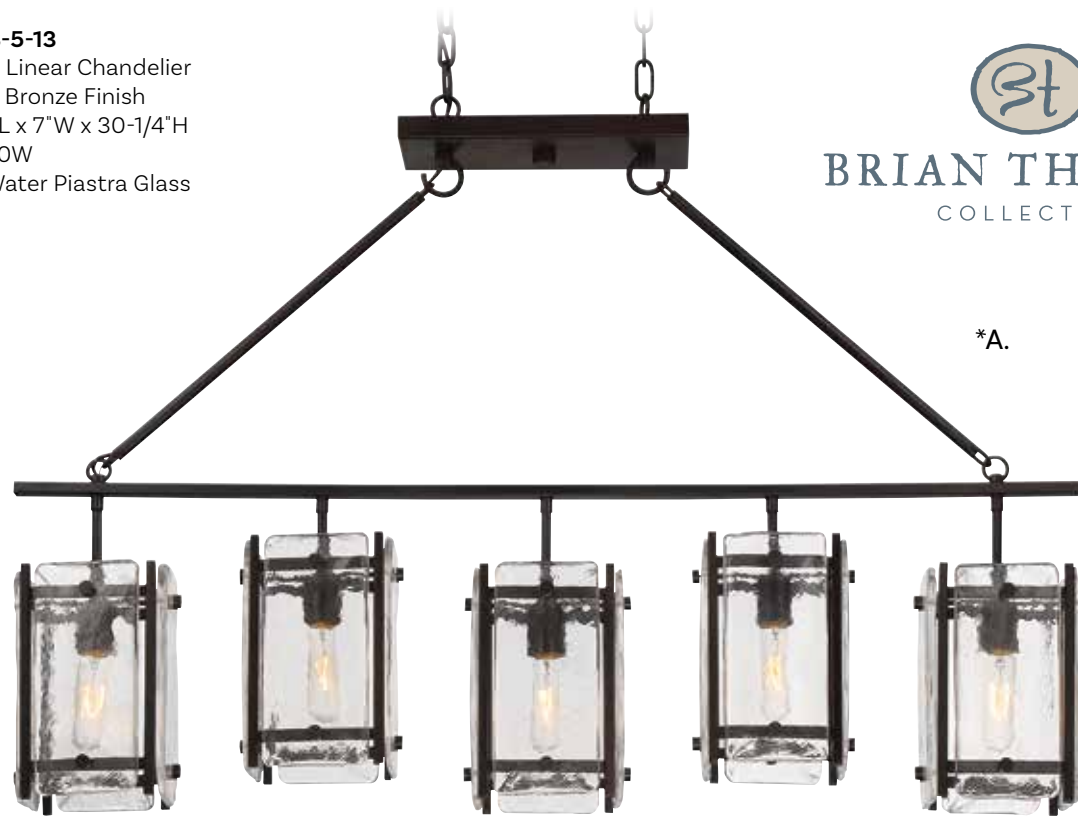

BRIAN THOMAS
 COLLECTION

*A.

*Includes 120" chain & wire

GLENWOOD

NEO-TRADITIONAL



B.



C.



*D.



*E.

B. 6-3042-4-13
 4-Light Semi-Flush
 English Bronze Finish
 14"W x 13-3/4"H
 4C 60W
 Clear Water Piastra Glass
 Metal Candle Covers

C. 9-3045-1-13
 1-Light Sconce
 English Bronze Finish
 8"W x 11"H x 4-1/4"E
 1C 60W
 Clear Water Piastra Glass
 Metal Candle Cover

D. 7-3040-6-13
 6-Light Pendant
 English Bronze Finish
 27"W x 27-1/8"H
 6C 60W
 Clear Water Piastra Glass
 Metal Candle Covers

E. 3-3041-4-13
 4-Light Pendant
 English Bronze Finish
 14"W x 30-1/8"H
 4C 60W
 Clear Water Piastra Glass
 Metal Candle Covers

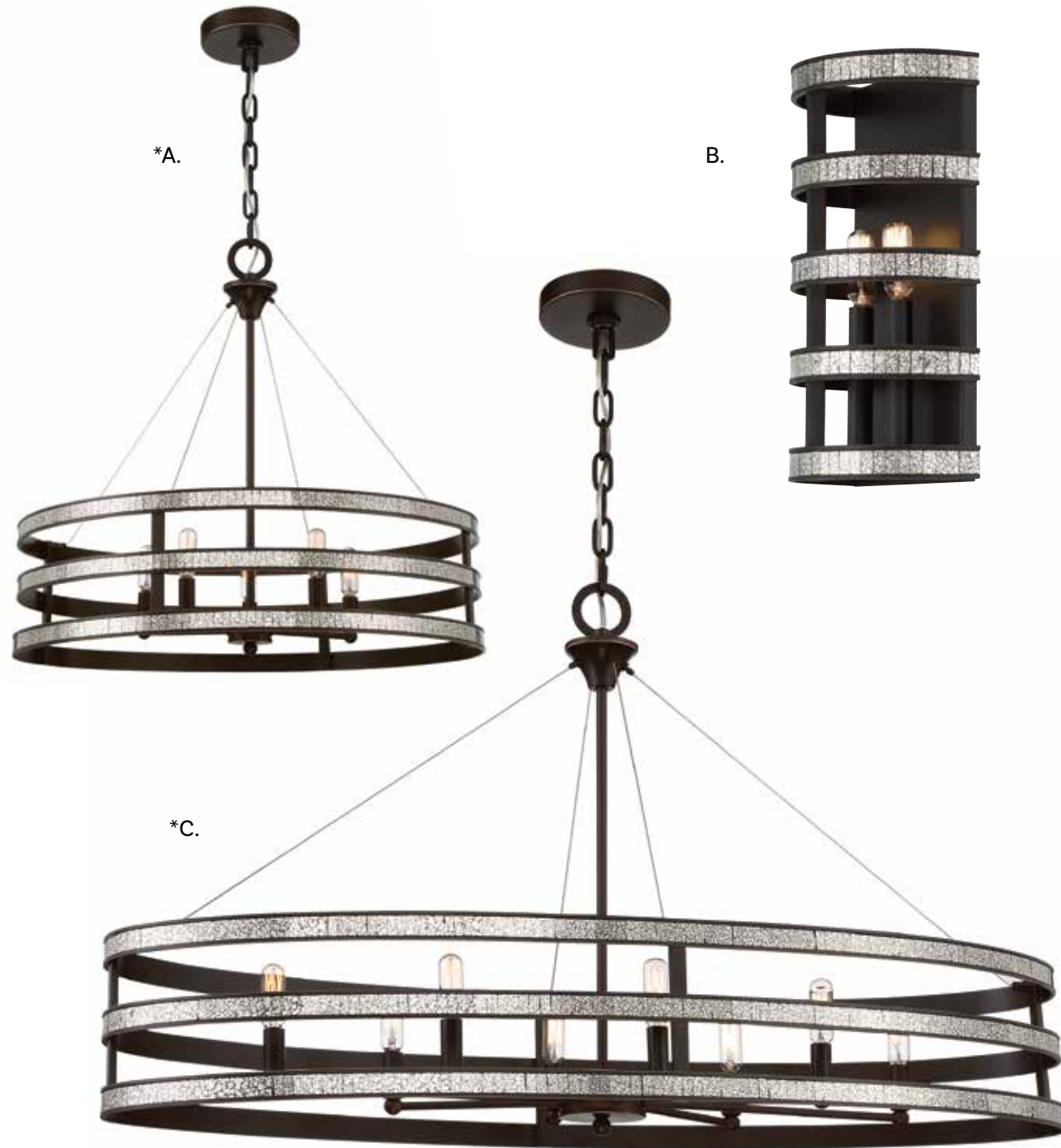

A. 7-1708-5-13
 5-Light Pendant
 English Bronze Finish
 25-1/2"W x 24"H
 5C 60W
 Antique Mirror Accents

B. 9-1710-2-13
 2-Light Sconce
 English Bronze Finish
 8"W x 14"H x 4-1/2"E
 2C 60W
 Antique Mirror Accents

C. 1-1709-8-13
 8-Light Linear Chandelier
 English Bronze Finish
 42"L x 18"W x 24"H
 8C 60W
 Antique Mirror Accents



*Includes 120" chain & wire



*Includes 12" & 6" extensions - additional stems available - 7-EXT

**Includes 120" chain & wire



Convertible: Semi-Flush/Pendant



Dual Mount Hanging System



A. 6-6684-4-127
 4-Light Convertible
 Semi-Flush Mount
 Noble Brass Finish
 16-1/2"W x 15-1/2"H
 Adj H 15-1/2" - 69-1/2"
 4C 60W
 Clear Crystal

B. 1-6686-6-127
 6-Light Chandelier
 Noble Brass Finish
 22-3/4"W x 28-1/4"H
 6C 60W
 Clear Crystal

C. 1-6688-8-127
 8-Light Chandelier
 Noble Brass Finish
 32"W x 35-1/2"H
 8C 60W
 Clear Crystal

A. 1-1846-4-127
 4-Light Chandelier
 Noble Brass Finish
 21"W x 19"H
 Adj H 19" - 73"
 4C 60W
 30° Swivel
 Clear Crystal

B. 1-1847-8-127
 8-Light Oval Chandelier
 Noble Brass Finish
 36"L x 15"W x 15"H
 Adj H 15" - 69"
 8C 60W
 30° Swivel
 Clear Crystal



A.



B.

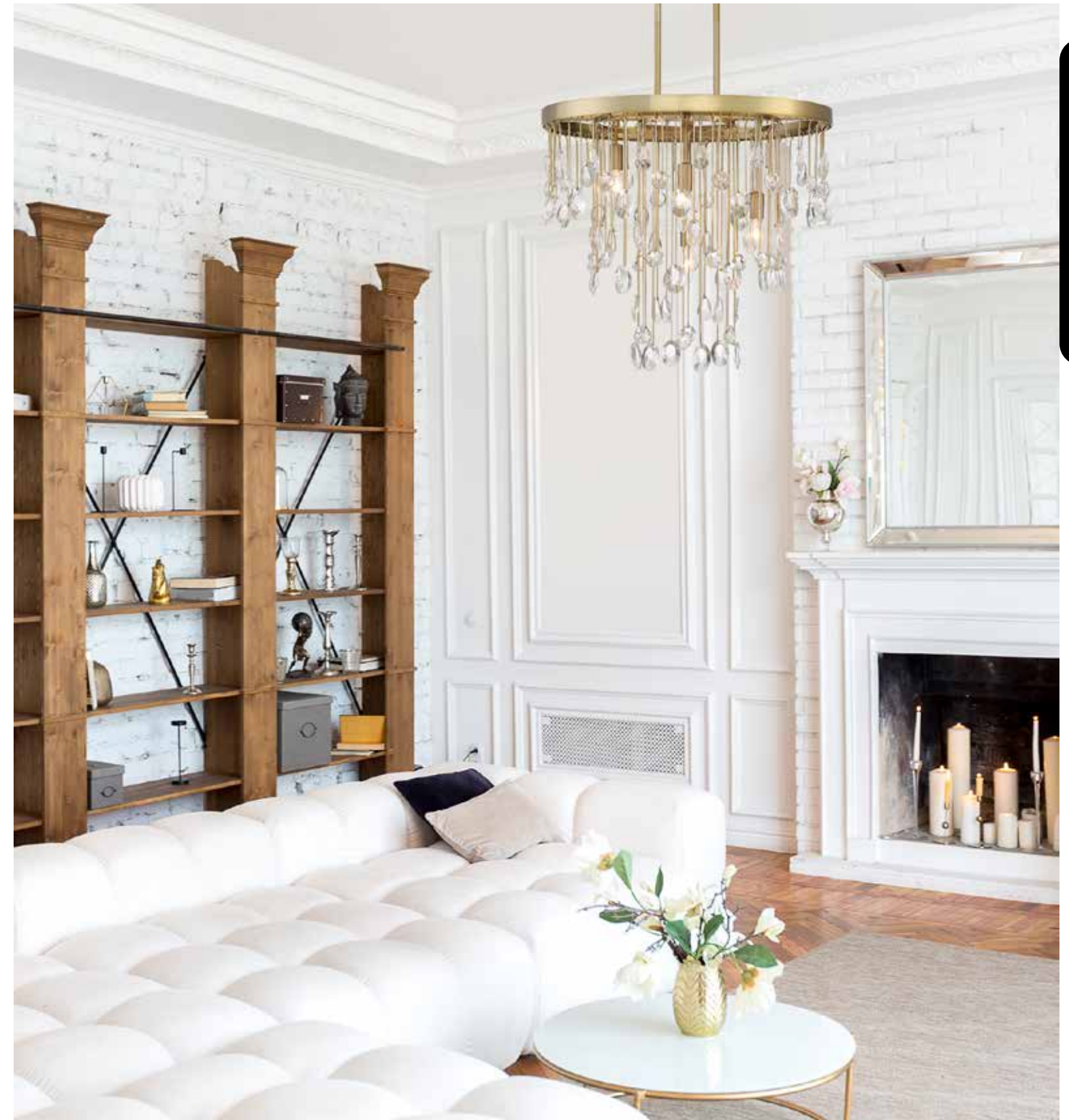

Includes 12" & 6" extensions - additional stems available - 7-EXT



Includes 12" & 6" extensions - additional stems available - 7-EXT



A.



Dual Mount Hanging System

- A. 1-2200-8-322**
8-Light Chandelier
Warm Brass Finish
32"W x 26"H
Adj H 26" - 80"
2.5W Dimmable G9 LED bulbs,
1100 Lumens, 3000K, 90+ CRI
Clear Crystal
G9 Bulbs Included



B.

- B. 1-2202-6-322**
6-Light Chandelier
Warm Brass Finish
26"W x 24"H
Adj H 24" - 78"
2.5W Dimmable G9 LED bulbs,
900 Lumens, 3000K, 90+ CRI
Clear Crystal
G9 Bulbs Included

LED



- A. 1-1865-3-322**
3-Light Mini-Chandelier
Warm Brass Finish
16"W x 19"H
3C 60W
Clear Crystal
- B. 1-1866-4-322**
4-Light Chandelier
Warm Brass Finish
20"W x 20"H
4C 60W
Clear Crystal
- C. 1-1867-10-322**
10-Light Chandelier
Warm Brass Finish
36"L x 17"W x 20"H
10C 60W
Clear Crystal

Includes 120" chain & wire



A. 7-8700-4-322
 4-Light Pendant
 Warm Brass Finish
 20"W x 22"H
 4C 60W
 Clear Crystal

B. 7-8701-6-322
 6-Light Pendant
 Warm Brass Finish
 28"W x 28"H
 6C 60W
 Clear Crystal

C. 1-8702-8-322
 8-Light Linear Chandelier
 Warm Brass Finish
 38"L x 16"W x 26"H
 8C 60W
 Clear Crystal

Includes 120" chain & wire



A. 7-1947-8-260
 8-Light Pendant
 True Gold Finish
 30"W x 30"H
 8E 60W
 Clear Crystal

B. 1-1946-10-260
 10-Light Chandelier
 True Gold Finish
 45"W x 39"H
 10E 60W
 Clear Crystal

Includes 120" chain & wire



BRIAN THOMAS
COLLECTION

1-3060-6-60
6-Light Chandelier
Avalite Finish
33"W x 35"H
6C 60W
Clear Crystal
Metal Candle Covers

Includes 120" chain & wire



A.

A. 7-2851-4-322
4-Light Pendant
Warm Brass Finish
19-7/8"W x 32-1/4"H
4C 60W
Clear Crystal



B.

B. 7-2852-6-322
6-Light Pendant
Warm Brass Finish
26"W x 23-1/2"H
6C 60W
Clear Crystal

Includes 120" chain & wire

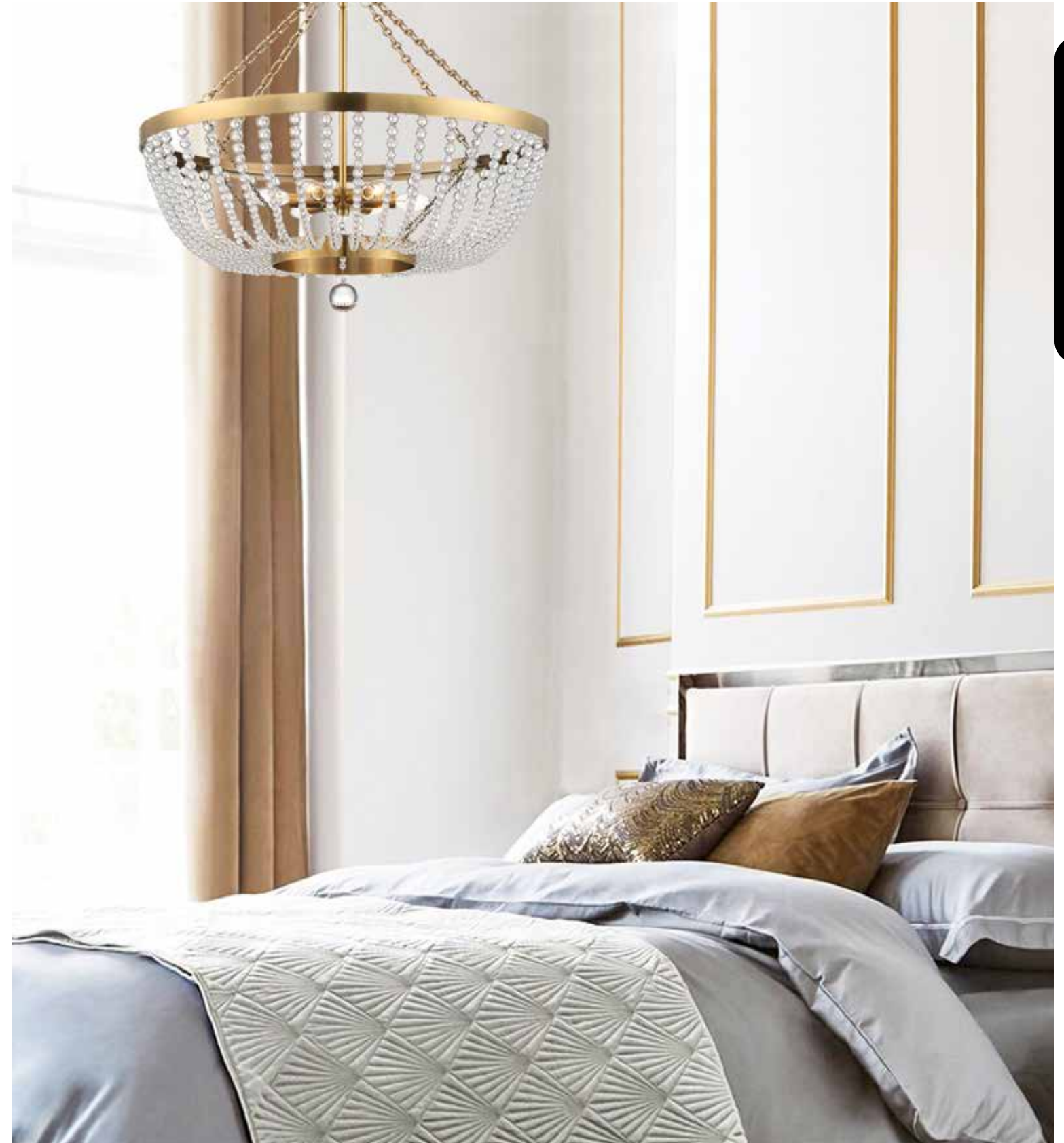



Dual Mount Hanging System

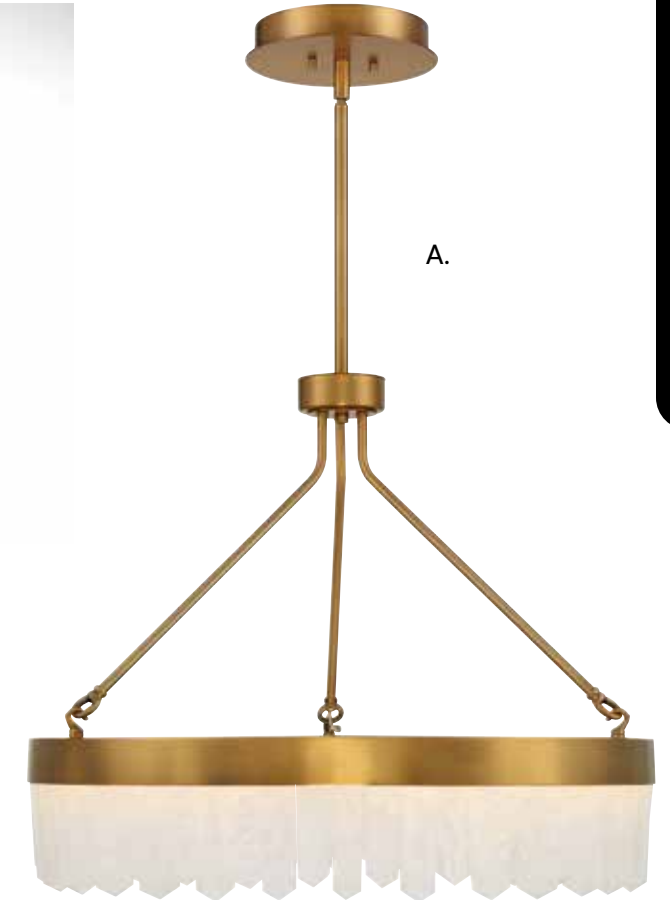

A.



B.

A. 7-1620-43-322
LED Pendant
Warm Brass Finish
27"W x 22"H
Adj H 22" - 76"
43W Integrated Dimmable LED
1450 Lumens, 3000K, 90+ CRI
Natural Calcite Elements

B. 7-1621-53-322
LED Pendant
Warm Brass Finish
34"W x 22"H
Adj H 22" - 76"
53W Integrated Dimmable LED
1800 Lumens, 3000K, 90+ CRI
Natural Calcite Elements



Includes 12" & 6" extensions - additional stems available - 7-EXTLG



*Includes 12" & 6" extensions - additional stems available - 7-EXTLG
 **Includes 12" & 6" extensions - additional stems available - 7-EXT

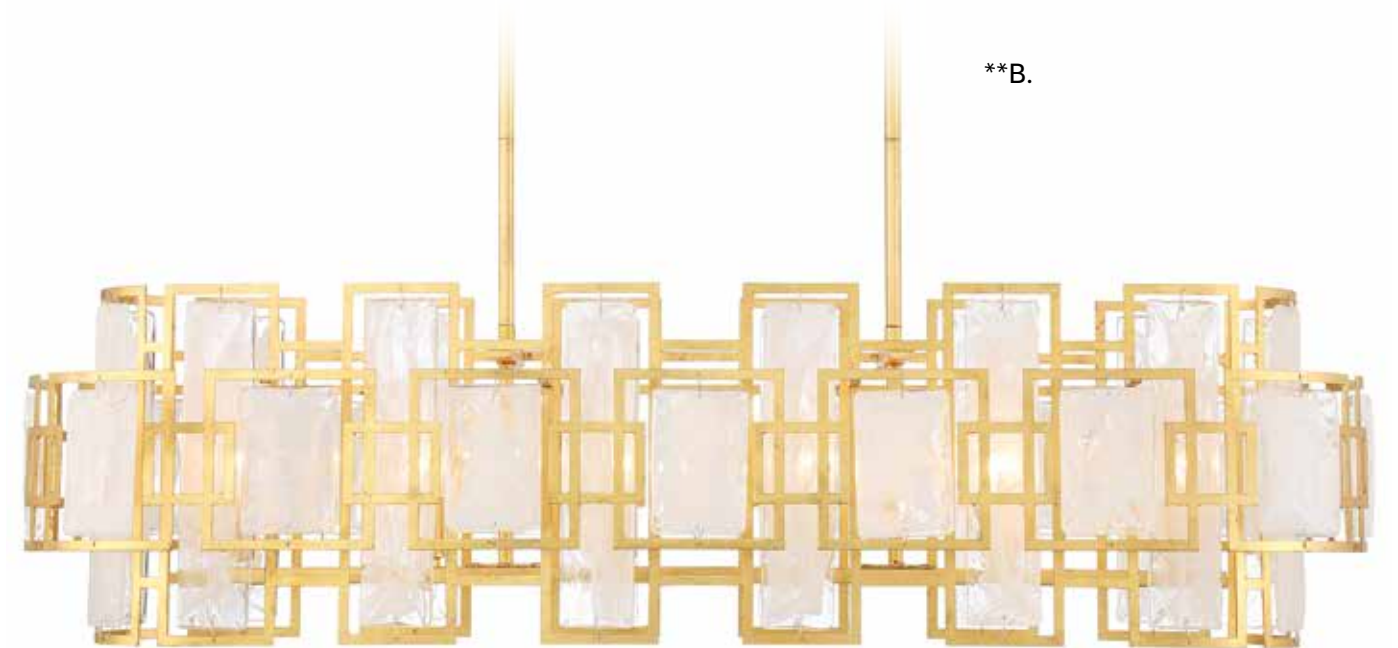
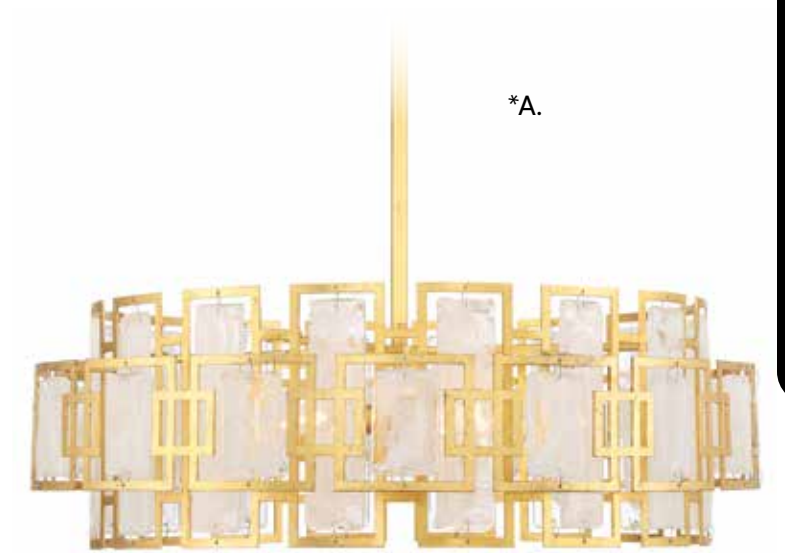

Dual Mount Hanging System

A. 1-2031-5-260
 5-Light Chandelier
 True Gold Finish
 26"W x 8-1/2"H
 Adj H 8-1/2" - 62-1/2"
 5C 60W
 Strie Piastra Glass

B. 1-2032-6-260
 6-Light Linear Chandelier
 True Gold Finish
 42"L x 12"W x 11"H
 Adj H 11" - 65"
 6C 60W
 Strie Piastra Glass



Sconce, Page 272

PYRAMID

PYRAMID

RENAISSANCE GUILD

RENAISSANCE GUILD



Dual Mount Hanging System

BRIAN THOMAS
 COLLECTION

A.



B.



A. 7-1610-6-322
 6-Light Pendant
 Warm Brass Finish
 29"W x 16"H
 Adj H 16" - 70"
 6C 60W
 Clear Crystal

B. 7-1610-6-89
 6-Light Pendant
 Matte Black Finish
 29"W x 16"H
 Adj H 16" - 70"
 6C 60W
 Clear Crystal

Includes 12" & 6" extensions - additional stems available - 7-EXTLG

MARQUISE

MARQUISE

RENAISSANCE GUILD



RENAISSANCE GUILD



A. 1-1669-4-143
4-Light Chandelier
Matte Black w/
Warm Brass Accents
24"W x 23"H
4E 60W
Optic Acrylic Elements

B. 1-1668-9-143
9-Light Chandelier
Matte Black w/
Warm Brass Accents
30"W x 27"H
9E 60W
Optic Acrylic Elements

Includes 120" chain & wire



Includes 12" & 6" extensions - additional stems available - 7-EXT



A.



Dual Mount Hanging System

A. 7-192-4-143
 4-Light Pendant
 Matte Black w/
 Warm Brass Accents
 24"W x 19"H
 Adj H 19" - 73"
 4E 60W
 Clear Crystal

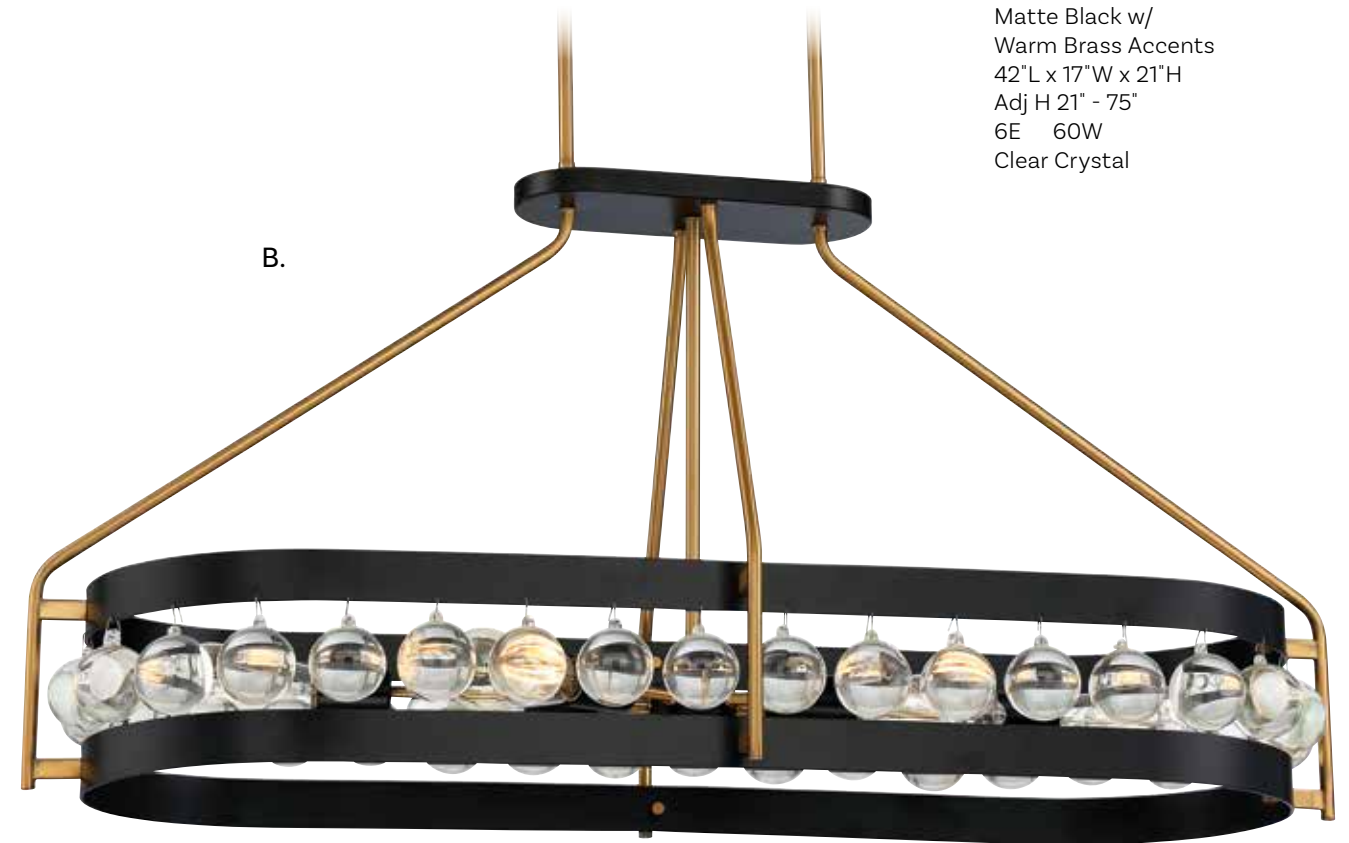

B.

B. 1-191-6-143
 6-Light Oval Chandelier
 Matte Black w/
 Warm Brass Accents
 42"L x 17"W x 21"H
 Adj H 21" - 75"
 6E 60W
 Clear Crystal



Convertible: Semi-Flush/Pendant

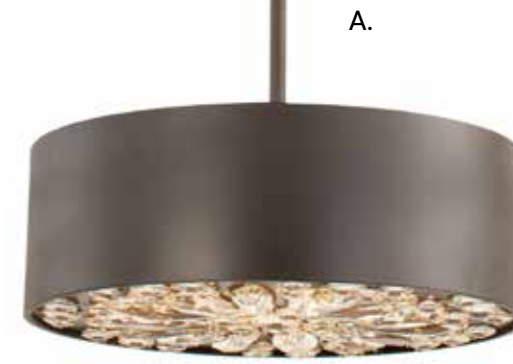

A.



Dual Mount Hanging System



B.

A. 6-1272-4-50
 4-Light Convertible Semi-Flush
 Black Cashmere Finish
 18"W x 6"H
 Adj H 6" - 60"
 4C 60W
 Clear Crystal

B. 7-1271-6-50
 6-Light Pendant
 Black Cashmere Finish
 28"W x 6"H
 Adj H 6" - 60"
 6C 60W
 Clear Crystal

Includes 12" & 6" extensions - additional stems available - 7-EXTLG

RENAISSANCE GUILD

RENAISSANCE GUILD



Dual Mount Hanging System

1-1270-6-50
6-Light Linear Chandelier
Black Cashmere Finish
18"W x 6"H x 48"L
Adj H 6" - 60"
6C 60W
Clear Crystal

Includes 12" & 6" extensions - additional stems available - 7-EXTLG



Includes 12" & 6" extensions - additional stems available - 7-EXTLG



Dual Mount Hanging System

- A. 1-3720-6-89**
6-Light Chandelier
Matte Black Finish
27-1/2"W x 18"H
Adj H 18" - 72"
6C 60W
Strie Piastra Glass
- B. 1-3722-10-89**
10-Light Chandelier
Matte Black Finish
35-1/2"W x 25"H
Adj H 25" - 79"
10C 60W
Strie Piastra Glass

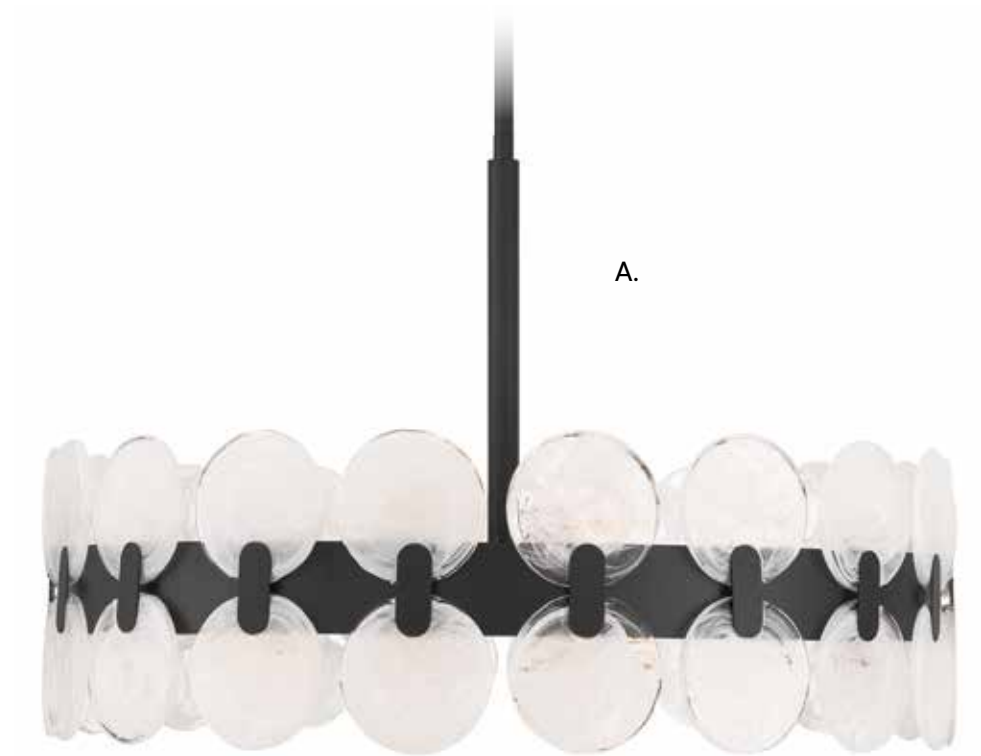

A.

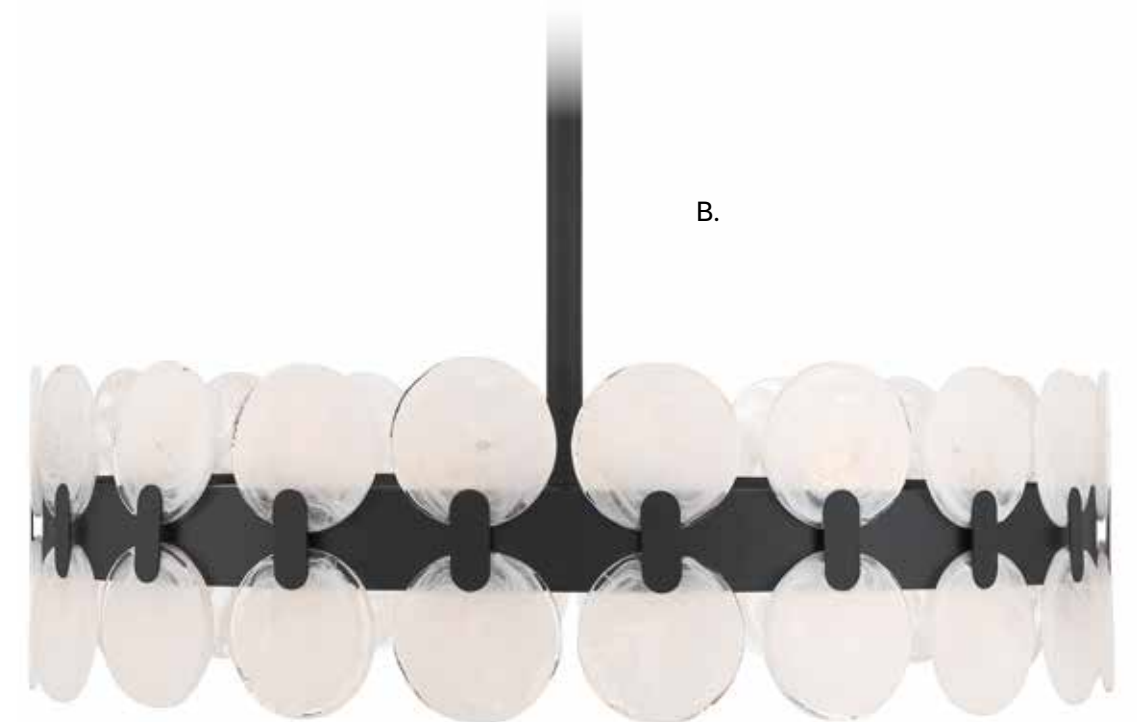

B.



A. 1-1938-36-89
 36-Light Chandelier
 Matte Black Finish
 60"W x 52"H
 36G9 4W
 Clear Crystal
G9 Bulbs Included

B. 1-1939-12-89
 12-Light Chandelier
 Matte Black Finish
 32"W x 30"H
 12G9 4W
 Clear Crystal
G9 Bulbs Included

C. 9-1940-2-89
 2-Light Sconce
 Matte Black Finish
 4-1/2"W x 12"H x 5-1/2"E
 2G9 4W
 Clear Crystal



*Includes 120" chain & wire



A. 1-6622-9-89
 9-Light Chandelier (8+1)
 Matte Black Finish
 40"W x 26"H
 Adj H 26" - 80"
 5W Integrated
 Dimmable LED
 2158 Lumens,
 3000K, 90+ CRI
 Water Glass

B. 1-6620-6-89
 6-Light Chandelier (5+1)
 Matte Black Finish
 30"W x 20"H
 Adj H 20" - 74"
 5W Integrated
 Dimmable LED
 1548 Lumens,
 3000K, 90+ CRI
 Water Glass

C. 9-6624-1-89
 1-Light Sconce
 Matte Black Finish
 5"W x 9"H x 4" E
 5W Integrated
 Dimmable LED
 342 Lumens,
 3000K, 90+ CRI
 Water Glass

LED

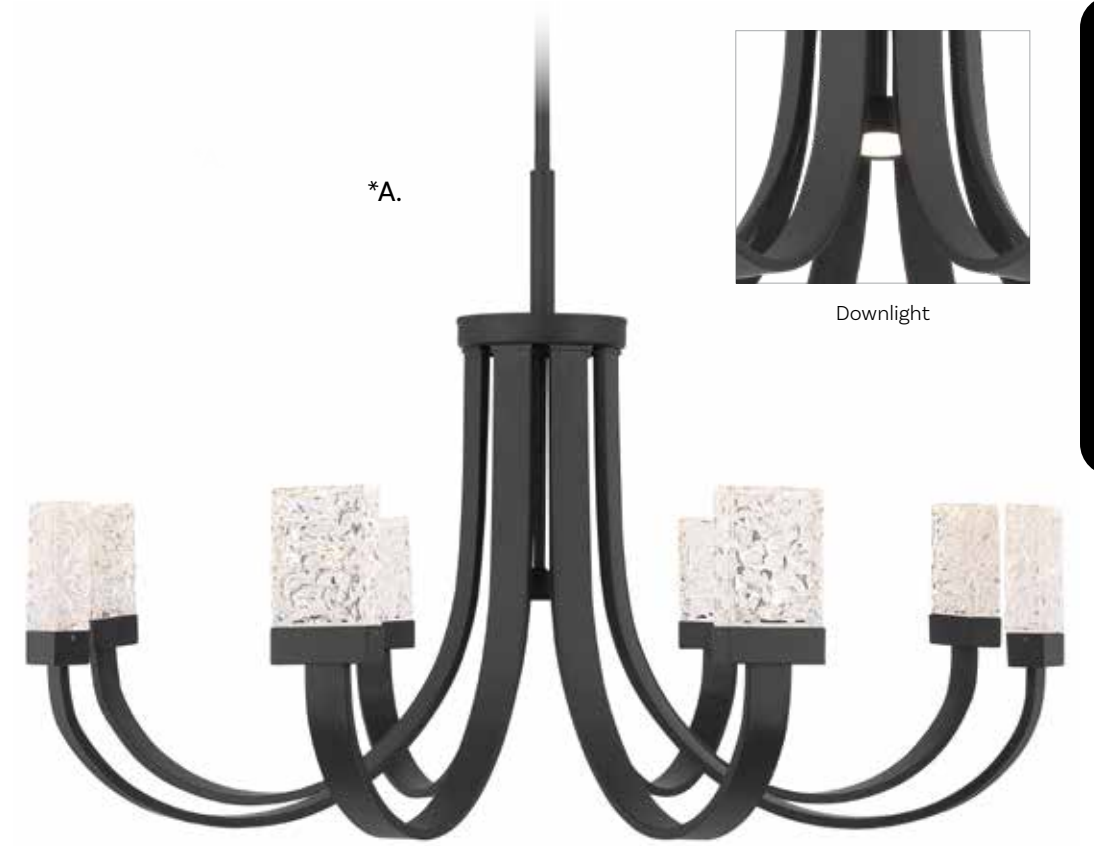

*A.



Downlight

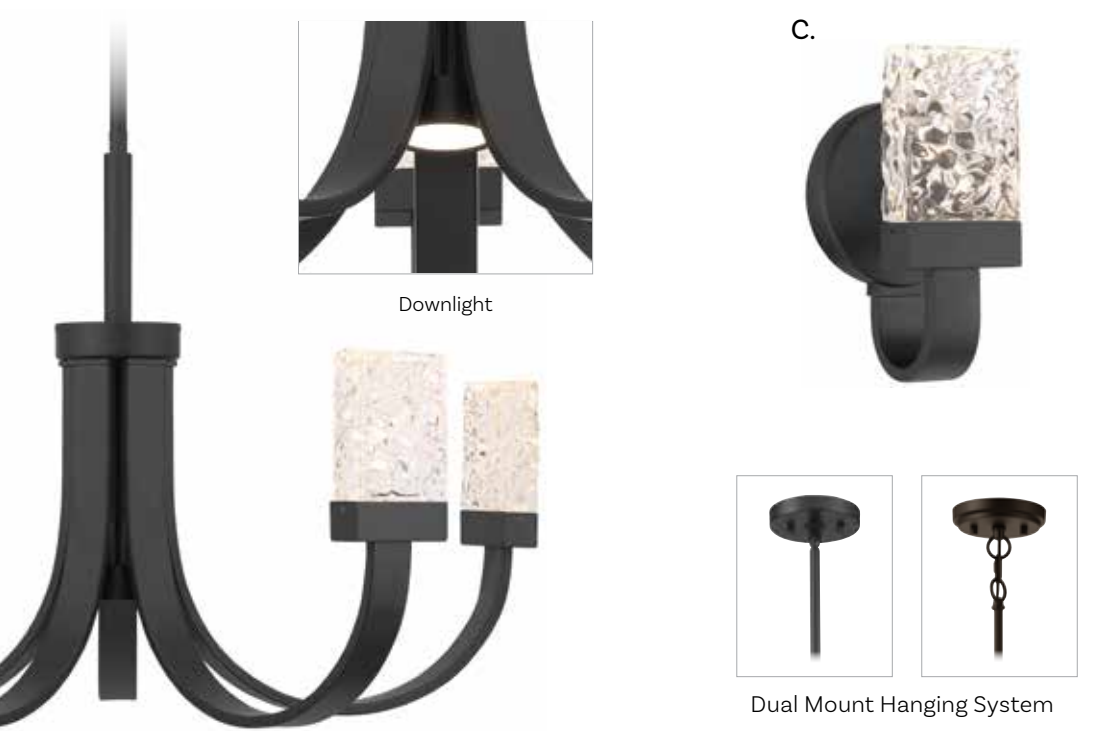

*B.



Downlight



C.



Dual Mount Hanging System

*Includes 12" & 6" extensions - additional stems available - 7-EXTLG

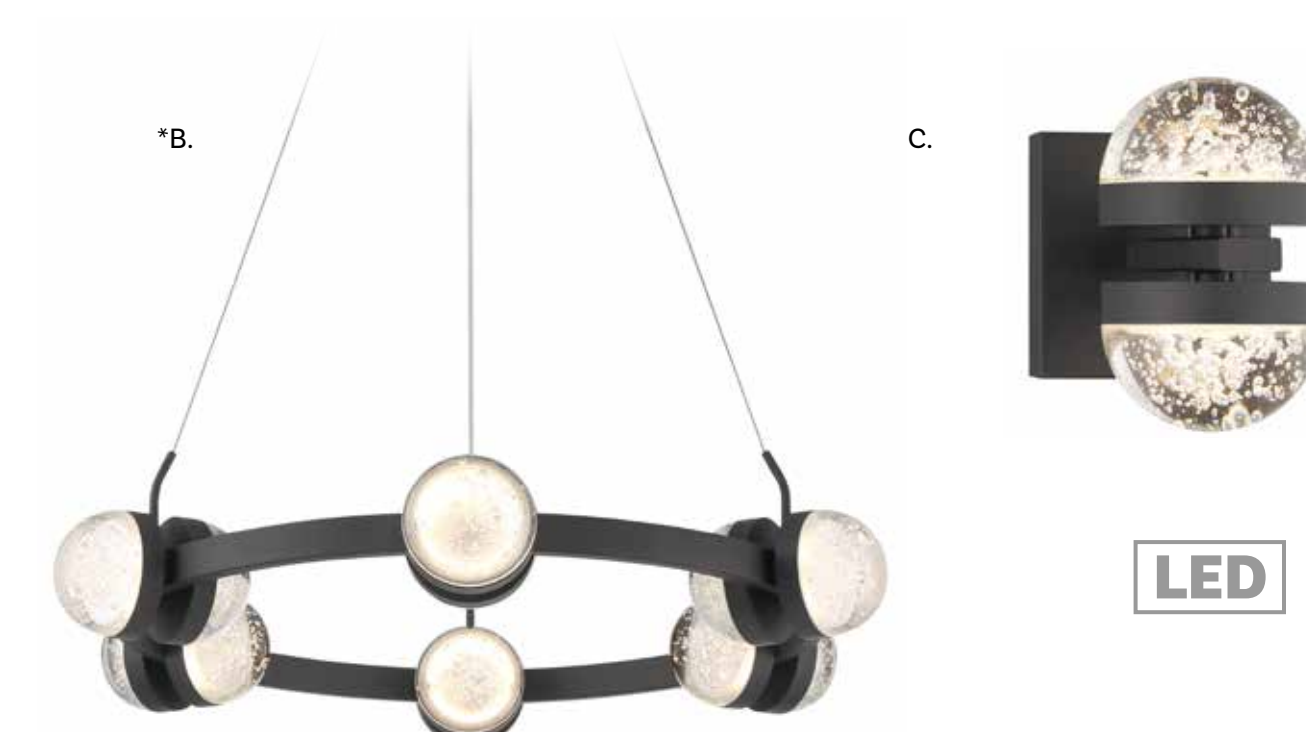
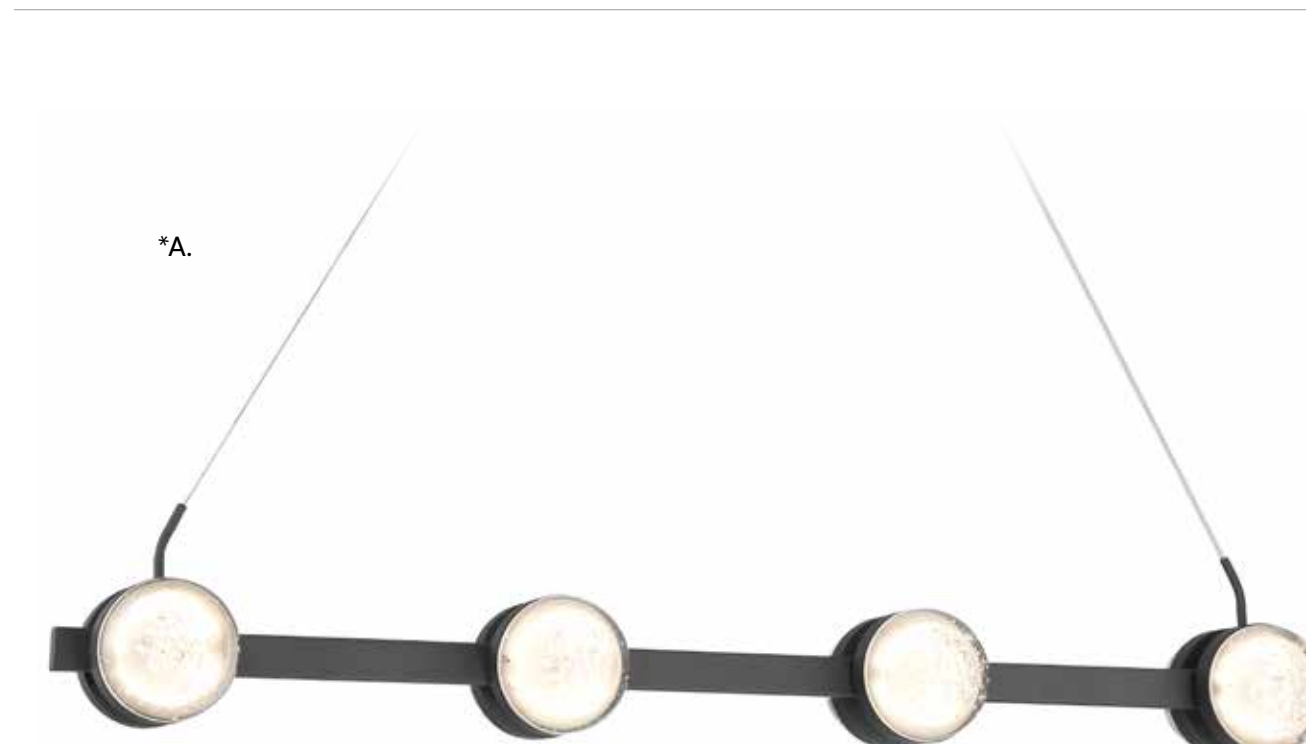

A. 1-4488-8-89
 8-Light Linear Chandelier
 Matte Black Finish
 6-1/4"W x 6-1/2"H x 40" L
 Adj H 6-1/2" - 126-1/2"
 4.5W Integrated Dimmable LED
 1645 Lumens, 3000K, 90+ CRI
 Bubble Glass

B. 1-4486-12-89
 12-Light Chandelier
 Matte Black Finish
 28"W x 6"H
 Adj H 6" - 126"
 4.5W Integrated Dimmable LED
 1945 Lumens, 3000K, 90+ CRI
 Bubble Glass

C. 9-4484-2-89
 2-Light Sconce
 Matte Black Finish
 4-1/2"W x 5-1/2"H x 5-3/4" E
 4.5W Integrated Dimmable LED
 496 Lumens, 3000K, 90+ CRI
 Bubble Glass

*Includes 120" lamp cord



A.

B.

A. 7-1878-4-66
 4-Light Pendant
 Matte Black w/
 Satin Nickel Finish
 21"W x 20"H
 4C 60W
 Clear Crystal

B. 7-1879-6-66
 6-Light Pendant
 Matte Black w/
 Satin Nickel Finish
 28"W x 25"H
 6C 60W
 Clear Crystal

Includes 120" chain & wire



7-2351-12-11
12-Light Pendant
Chrome Finish
38"W x 31"H
Adj H 31" - 85"
12G9 40W
30° Swivel
Hand Made Marble Glass
G9 Bulbs Included



BRIAN THOMAS
COLLECTION



Includes 12" & 6" extensions - additional stems available - **7-EXTLG**



B.

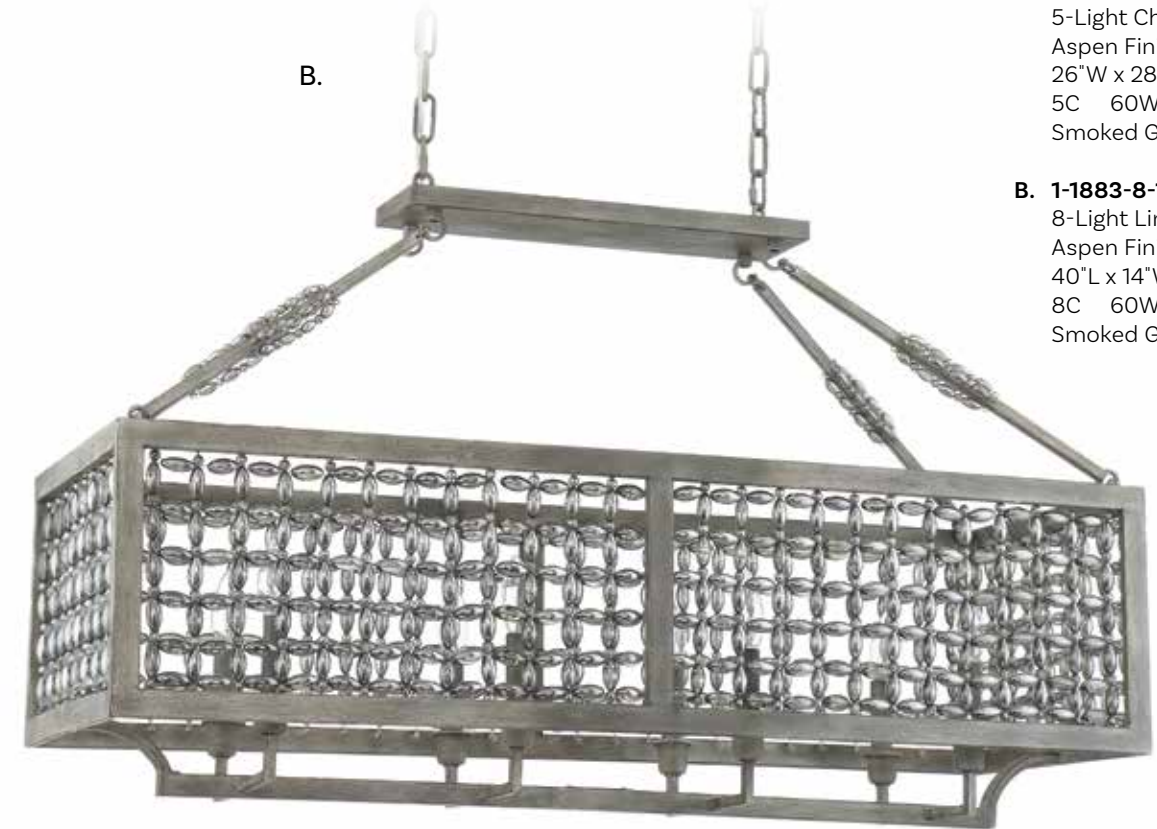

- A. 1-1882-5-178**
5-Light Chandelier
Aspen Finish
26"W x 28"H
5C 60W
Smoked Gray Crystal
- B. 1-1883-8-178**
8-Light Linear Chandelier
Aspen Finish
40"L x 14"W x 24"H
8C 60W
Smoked Gray Crystal

Includes 120" chain & wire

TODAY'S CLASSIC STYLE



TODAY'S CLASSIC STYLE

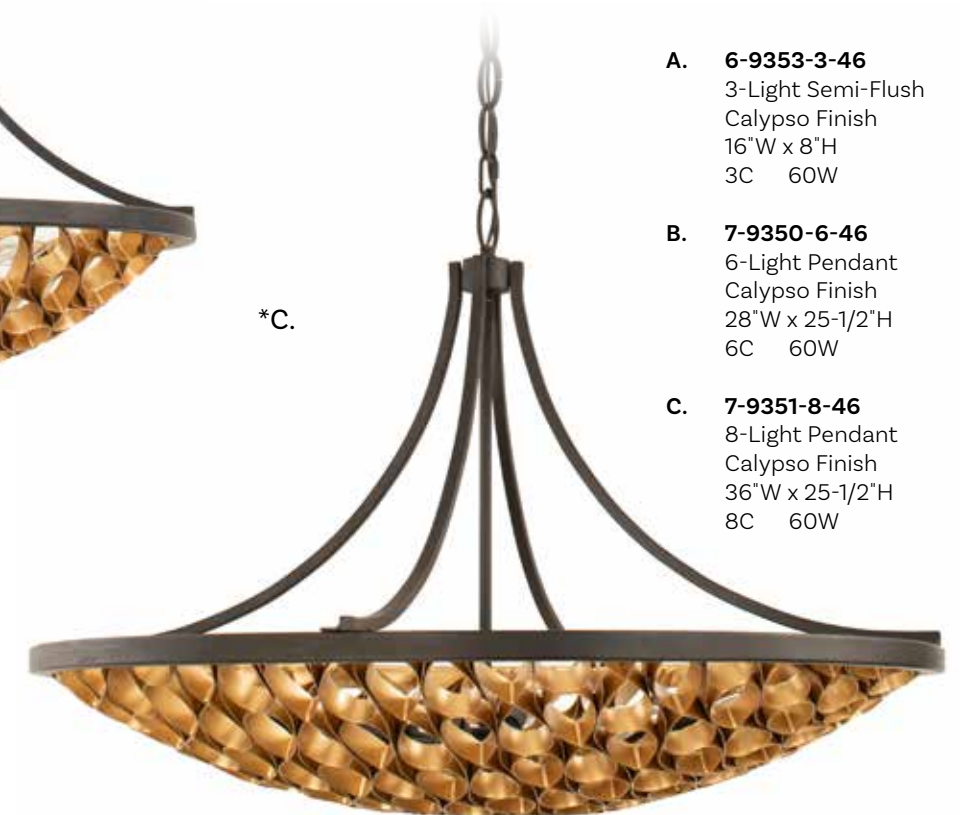

- A. 6-9353-3-46**
3-Light Semi-Flush
Calypso Finish
16"W x 8"H
3C 60W
- B. 7-9350-6-46**
6-Light Pendant
Calypso Finish
28"W x 25-1/2"H
6C 60W
- C. 7-9351-8-46**
8-Light Pendant
Calypso Finish
36"W x 25-1/2"H
8C 60W

*Includes 120" chain & wire

TODAY'S CLASSIC STYLE



TODAY'S CLASSIC STYLE



7-9352-10-46
10-Light Orb Pendant
Calypso Finish
26" W x 24-1/4" H
10C 60W

Includes 120" chain & wire

TODAY'S CLASSIC STYLE



A.



B.



*C.

*Includes 12" & 6" extensions - additional stems available - 7-EXTLG



TODAY'S CLASSIC STYLE



Dual Mount Hanging System

A. 6-1695-4-143
 4-Light Semi-Flush
 Matte Black w/
 Warm Brass Accents
 24"W x 8"H
 4E 60W
 Strie Piastra Glass

B. 9-1697-1-143
 1-Light Sconce
 Matte Black w/
 Warm Brass Accents
 6"W x 12"H x 4-1/2"E
 1E 60W
 Strie Piastra Glass

C. 7-1696-5-143
 5-Light Pendant
 Matte Black w/
 Warm Brass Accents
 28"W x 17"H
 Adj H 17" x 71"
 5E 60W
 Strie Piastra Glass

FAN D'LIER®
HAYWARD

FAN D'LIER®
HAYWARD

TODAY'S CLASSIC STYLE



FAN NUMBER	24-FD-1698-143
MOTOR FINISH	Matte Black
BLADE FINISH	Black
SHADE FINISH	Strie Piastra Glass

ENERGY USE AT HIGH SPEED		
Airflow Use 1,079 Cu Ft/Min	Electricity Use 28W Excludes Lights	Airflow Efficiency 38.54 Cu Ft/Min/W
Compare: 36" to 48" ceiling fans have airflow efficiencies ranging from approximately 71 to 86 cu. ft. per min. per watt at high speed.		

- Motor Size 80 x 70
- 12" Blade Span
- 23"W x 15-1/2"H (Cage Only)
- 16° Blade Pitch
- Downrods Included 4" & 18"
- Additional Downrod Lengths Sold Separately
- ABS Blades & Integrated Fan Light Included
- 4E 8W Dimmable LED
870 Lumens, 3000K, 90+ CRI
- Not Hugger Kit Adaptable
- Handheld Remote Included
(RMT-AC-UNIVERSAL)



Handheld Remote Control Included
 RMT-AC-UNIVERSAL



TODAY'S CLASSIC STYLE

TODAY'S CLASSIC STYLE



A. 1-1635-5-143
 5-Light Chandelier
 Matte Black w/ Warm Brass Accents
 34"W x 16"H
 Adj H 16" - 70"
 11W Dimmable LED
 1700 Lumens, 3000K, 90+ CRI

B. 1-1636-8-143
 8-Light Linear Chandelier
 Matte Black w/ Warm Brass Accents
 60"L x 18"W x 23"H
 Adj H 23" - 77"
 11W Dimmable LED
 2050 Lumens, 3000K, 90+ CRI

C. 1-1637-8-143
 8-Light Chandelier
 Matte Black w/ Warm Brass Accents
 42"W x 15"H
 Adj H 15" - 69"
 7W Dimmable LED
 1550 Lumens, 3000K, 90+ CRI

TODAY'S CLASSIC STYLE



Dual Mount Hanging System

LED

*Includes 12" & 6" extensions - additional stems available - **7-EXT**
 Includes 12" & 6" extensions - additional stems available - **7-EXTLG



A. ALBERTI
6-1822-4-143
 4-Light Flush Mount
 Matte Black w/
 Warm Brass Accents
 18-1/2"W x 5-1/4"H
 4E 60W
 White Alabaster Glass

B. ABEL
7-1643-1-143
 1-Light Mini Pendant
 Matte Black w/
 Warm Brass Accents
 8-1/4"W x 13-3/4"H
 Adj H 13-3/4" - 67-3/4"
 8W Integrated
 Dimmable LED
 300 Lumens, 3000K,
 90+ CRI
 White Opal Glass

C. ABEL
1-1641-4-143
 4-Light Chandelier
 Matte Black w/
 Warm Brass Accents
 26"W x 17"H
 Adj H 17" - 137"
 6W Integrated
 Dimmable LED
 1100 Lumens, 3000K,
 90+ CRI
 White Opal Glass

D. ABEL
1-1642-10-143
 10-Light Chandelier
 Matte Black w/
 Warm Brass Accents
 45"W x 17"H
 Adj H 17" - 137"
 6W Integrated
 Dimmable LED
 2700 Lumens, 3000K,
 90+ CRI
 White Opal Glass



A.

*B.



Dual Mount Hanging System

**C.



**D.



LED



Bath, Page 288

*Includes 12" & 6" extensions - additional stems available - **7-EXT**

**Includes 120" of cable

TODAY'S CLASSIC STYLE



TODAY'S CLASSIC STYLE

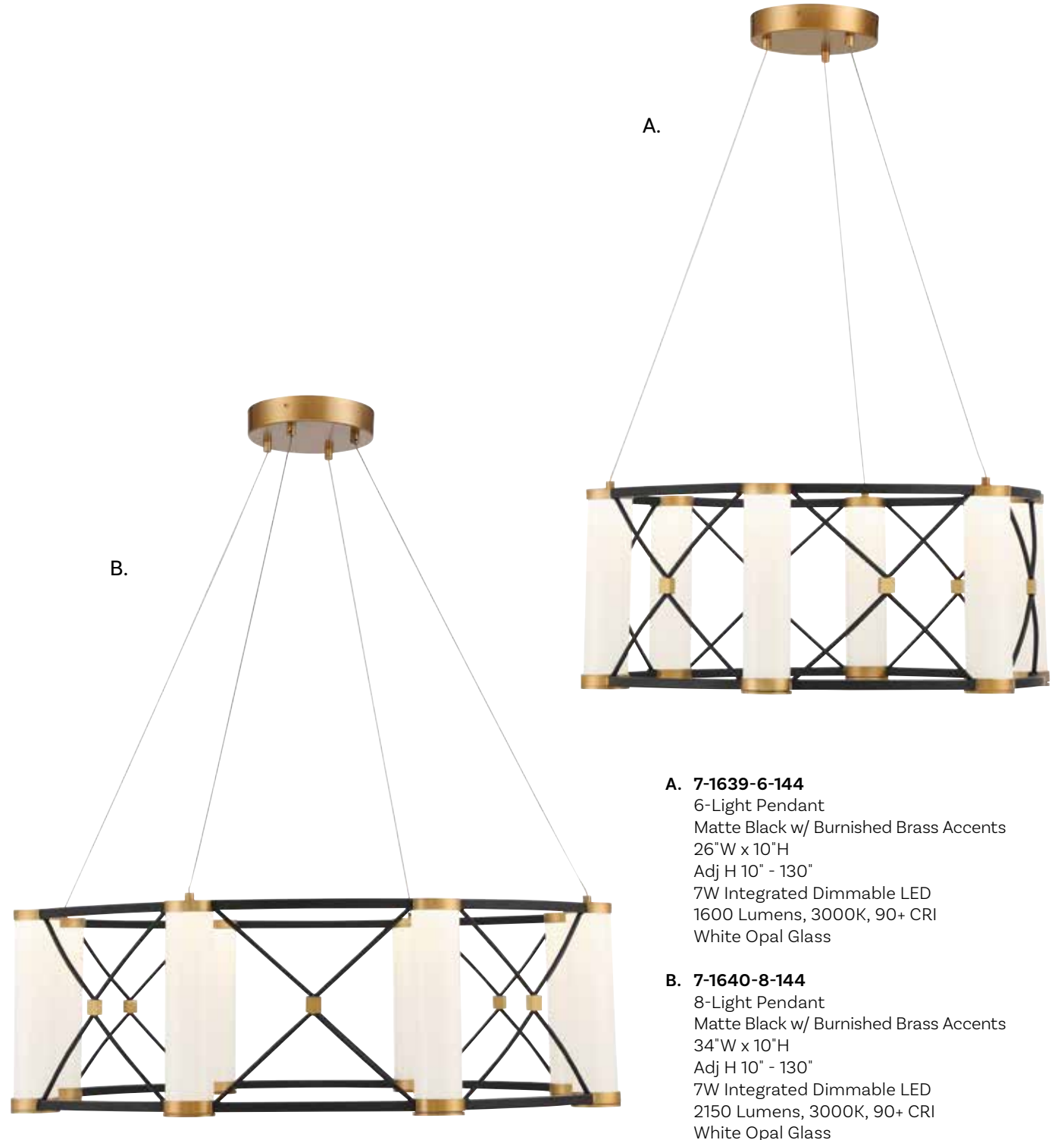

- A. 7-1639-6-144**
 6-Light Pendant
 Matte Black w/ Burnished Brass Accents
 26"W x 10"H
 Adj H 10" - 130"
 7W Integrated Dimmable LED
 1600 Lumens, 3000K, 90+ CRI
 White Opal Glass
- B. 7-1640-8-144**
 8-Light Pendant
 Matte Black w/ Burnished Brass Accents
 34"W x 10"H
 Adj H 10" - 130"
 7W Integrated Dimmable LED
 2150 Lumens, 3000K, 90+ CRI
 White Opal Glass



Includes 120" of cable

TODAY'S CLASSIC STYLE



TODAY'S CLASSIC STYLE



Dual Mount Hanging System

A. 1-1893-6-143
 6-Light Chandelier
 Matte Black w/
 Warm Brass Accents
 28"W x 24"H
 Adj H 24" - 78"
 6C 60W
 White Fabric

B. 1-1887-6-143
 6-Light Chandelier
 Matte Black w/
 Warm Brass Accents
 28"W x 20"H
 Adj H 20" - 74"
 6C 60W
 White Fabric

C. 1-1889-8-143
 8-Light Linear Chandelier
 Matte Black w/
 Warm Brass Accents
 42"L x 16"W x 16"H
 Adj H 16" - 70"
 8C 60W
 White Fabric

Includes 12" & 6" extensions - additional stems available - 7-EXT



Sconce, Page 275

CAPELLA

CAPELLA

TODAY'S CLASSIC STYLE

TODAY'S CLASSIC STYLE



Dual Mount Hanging System

A. 7-5402-4-79
 4-Light Pendant
 English Bronze w/
 Warm Brass Finish
 16"W x 28"H
 4C 60W
 Clear Water Glass
 Metal Candle Covers

B. 1-5404-8-79
 8-Light Linear Chandelier
 English Bronze w/
 Warm Brass Finish
 42"L x 16"W x 12"H
 Adj H 12" - 66"
 8C 60W
 Clear Water Glass
 Metal Candle Covers

*Includes 120" chain & wire
 **Includes 12" & 6" extensions - additional stems available - 7-EXT



Dual Mount Hanging System

A. 9-1905-2-143
 2-Light Sconce
 Matte Black w/
 Warm Brass Accents
 10-1/2"W x 20"H x 5"E
 2C 60W
 Clear Ribbed Glass

B. 1-1906-6-143
 6-Light Chandelier
 Matte Black w/
 Warm Brass Accents
 28"W x 21"H
 Adj H 21" - 75"
 6C 60W
 Clear Ribbed Glass

C. 1-1907-8-143
 8-Light Linear Chandelier
 Matte Black w/
 Warm Brass Accents
 40"L x 16"W x 14"H
 Adj H 14" - 70"
 8C 60W
 Clear Ribbed Glass



A.



*B.



*C.

*Includes 12" & 6" extensions - additional stems available - 7-EXT

TODAY'S CLASSIC STYLE

TODAY'S CLASSIC STYLE



- A. 1-1975-5-143**
5-Light Chandelier
Matte Black w/
Warm Brass Accents
27"W x 17"H
Adj H 17" - 71"
5E 60W
Clear Outer Glass
White Opal Chimney
- B. 1-1976-6-143**
6-Light Chandelier
Matte Black w/
Warm Brass Accents
28"W x 17-1/2"H
Adj H 17-1/2" - 71-1/2"
6E 60W
Clear Outer Glass
White Opal Chimney
- C. 7-1983-1-143**
1-Light Pendant
Matte Black w/
Warm Brass Accents
17"W x 9"H
Adj H 9" - 63"
1E 60W
Clear Outer Glass
White Opal Chimney
- D. 1-1982-4-143**
4-Light Linear Chandelier
Matte Black w/
Warm Brass Accents
48"L x 7"W x 7-1/2"H
Adj H 7-1/2" - 61-1/2"
4E 60W
Clear Outer Glass
White Opal Chimney

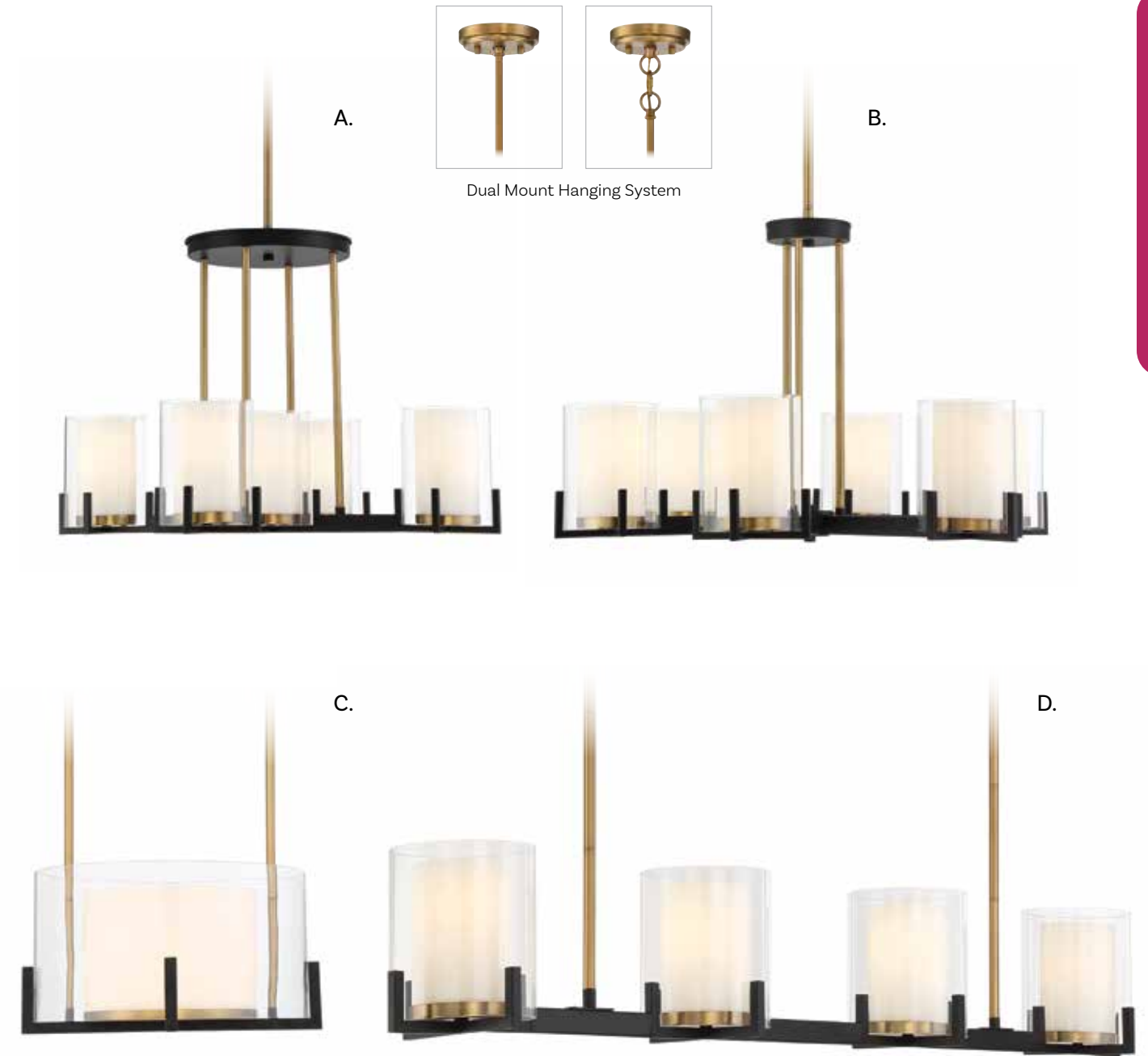

Includes 12" & 6" extensions - additional stems available - **7-EXT**

Ceiling, Page 318

Sconce, Page 290

ECLIPSE

ECLIPSE

TODAY'S CLASSIC STYLE

TODAY'S CLASSIC STYLE



- A. 1-1811-4-143**
4-Light Linear Chandelier
Matte Black w/
Warm Brass Accents
26"L x 5-3/4"W x 7-1/2"H
Adj H 7-1/2" - 127-1/2"
4E 60W
- B. 1-1813-5-143**
5-Light Linear Chandelier
Matte Black w/
Warm Brass Accents
36"L x 14"W x 10"H
Adj H 10" - 64"
5E 60W
- C. 7-1810-1-143**
1-Light Pendant
Matte Black w/
Warm Brass Accents
10"W x 13"H
Adj H 13" - 133"
1E 60W
- D. 7-1812-4-143**
4-Light Pendant
Matte Black w/
Warm Brass Accents
22"W x 8"H
Adj H 8" - 62"
4E 60W



*Includes 12" & 6" extensions - additional stems available - 7-EXTLG

A. 7-188-6-172
 6-Light Pendant
 White w/ Polished Nickel Accents
 19"W x 25"H
 6C 60W
 Metal Shade

B. 1-187-3-172
 3-Light Linear Chandelier
 White w/ Polished Nickel Accents
 42"L x 10"W x 11"H
 Adj H 11" - 65"
 3E 60W
 Metal Shade



Dual Mount Hanging System

**A.



**C.



C. 7-188-6-143
 6-Light Pendant
 Matte Black w/ Warm Brass Accents
 19"W x 25"H
 6C 60W
 Metal Shade

D. 1-187-3-143
 3-Light Linear Chandelier
 Matte Black w/ Warm Brass Accents
 42"L x 10"W x 11"H
 Adj H 11" - 65"
 3E 60W
 Metal Shade



Dual Mount Hanging System

*B.



*D.



*Includes 12" & 6" extensions - additional stems available - 7-EXT

**Includes 120" chain & wire

KELLERMAN

TODAY'S CLASSIC STYLE



Dual Mount Hanging System



*A.

A. 7-1929-4-261
4-Light Pendant
Matte Black w/
True Gold Accents
21"W x 8-1/2"H
Adj. H 8-1/2" - 62-1/2"
4E 60W



*Includes 12" & 6" extensions - additional stems available - 7-EXTLG

**Includes 120" chain & wire

KIAN

TODAY'S CLASSIC STYLE



**B.



B. 7-1920-3-261
3-Light Pendant
Matte Black w/
True Gold Accents
22"W x 26"H
3E 60W
White Fabric Shade



KIRSCH

KELVIN

TODAY'S CLASSIC STYLE

TODAY'S CLASSIC STYLE

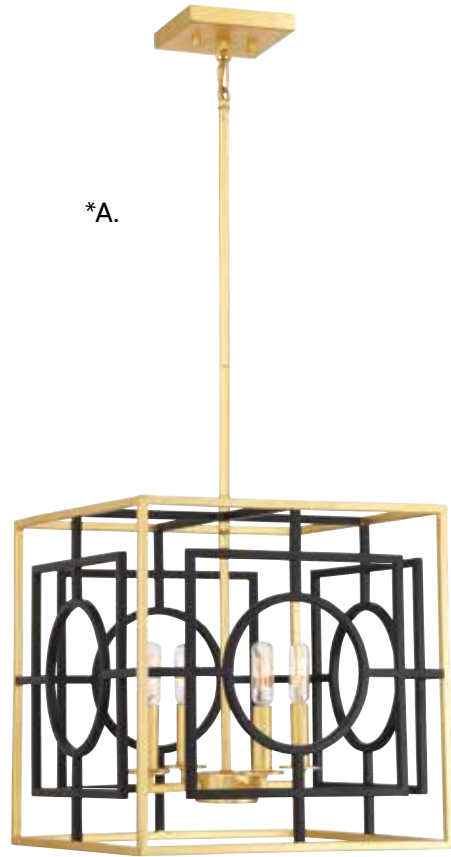

*A.



*C.



B.



Dual Mount Hanging System

A. 3-1923-4-261
4-Light Pendant
Matte Black w/
True Gold Accents
15"W x 15"H
Adj. H 15" - 69"
4C 60W

B. 9-1924-1-261
1-Light Sconce
Matte Black w/
True Gold Accents
6"W x 13"H x
5-1/2"E
1C 60W

C. 7-1927-6-143
6-Light Pendant
Matte Black w/
Warm Brass Accents
20"W x 16"H
Adj H 16" - 70"
6C 60W

*Includes 12" & 6" extensions - additional stems available - 7-EXT



A. 1-8042-6-79
 6-Light Linear Chandelier
 English Bronze w/
 Warm Brass Accents
 32" L x 14-3/4" W x 20-3/4" H
 Adj H 20-3/4" - 74-3/4"
 6C 60W
 30° Swivel
 Clear Glass
 Metal Candle Covers



B. 7-8041-5-79
 5-Light Pendant
 English Bronze w/
 Warm Brass Accents
 24" W x 14-3/4" H
 Adj H 14-3/4" - 68-3/4"
 5C 60W
 30° Swivel
 Clear Glass
 Metal Candle Covers

Includes 12" & 6" extensions - additional stems available - 7-EXTLG



A. 9-8073-2-51
2-Light Sconce
Vintage Black w/
Warm Brass Accents
12"W x 15"H x 6"E
2C 60W
Clear Glass



B. 1-8070-8-51
8-Light Chandelier
Vintage Black w/
Warm Brass Accents
32"W x 24"H
Adj H 24" - 78"
8C 60W
30° Swivel
Clear Glass



C. 3-8072-4-51
4-Light Pendant
Vintage Black w/
Warm Brass Accents
17-1/4"W x 23-1/4"H
Adj H 23-1/4" - 77-1/4"
4C 60W
30° Swivel
Clear Glass

*Includes 12" & 6" extensions - additional stems available - 7-EXT



A. 7-4199-6-83
 6-Light Pendant
 Bisque White Finish
 28"W x 23-1/4"H
 6C 60W



B. 7-4199-6-171
 6-Light Pendant
 Burnished Brass Finish
 28"W x 23-1/4"H
 6C 60W

Includes 120" chain & wire



7-4618-6-83
6-Light Pendant
Bisque White Finish
29"W x 27"H
6C 60W

Includes 120" chain & wire



A. 1-1760-8-198
 8-Light Chandelier
 Natural Antler Finish
 40"W x 38"H
 Adj H 38" - 92"
 8C 60W

B. 1-1760-8-80
 8-Light Chandelier
 Matte White Finish
 40"W x 38"H
 Adj H 38" - 92"
 8C 60W

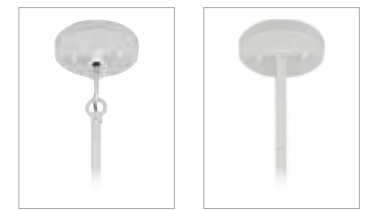
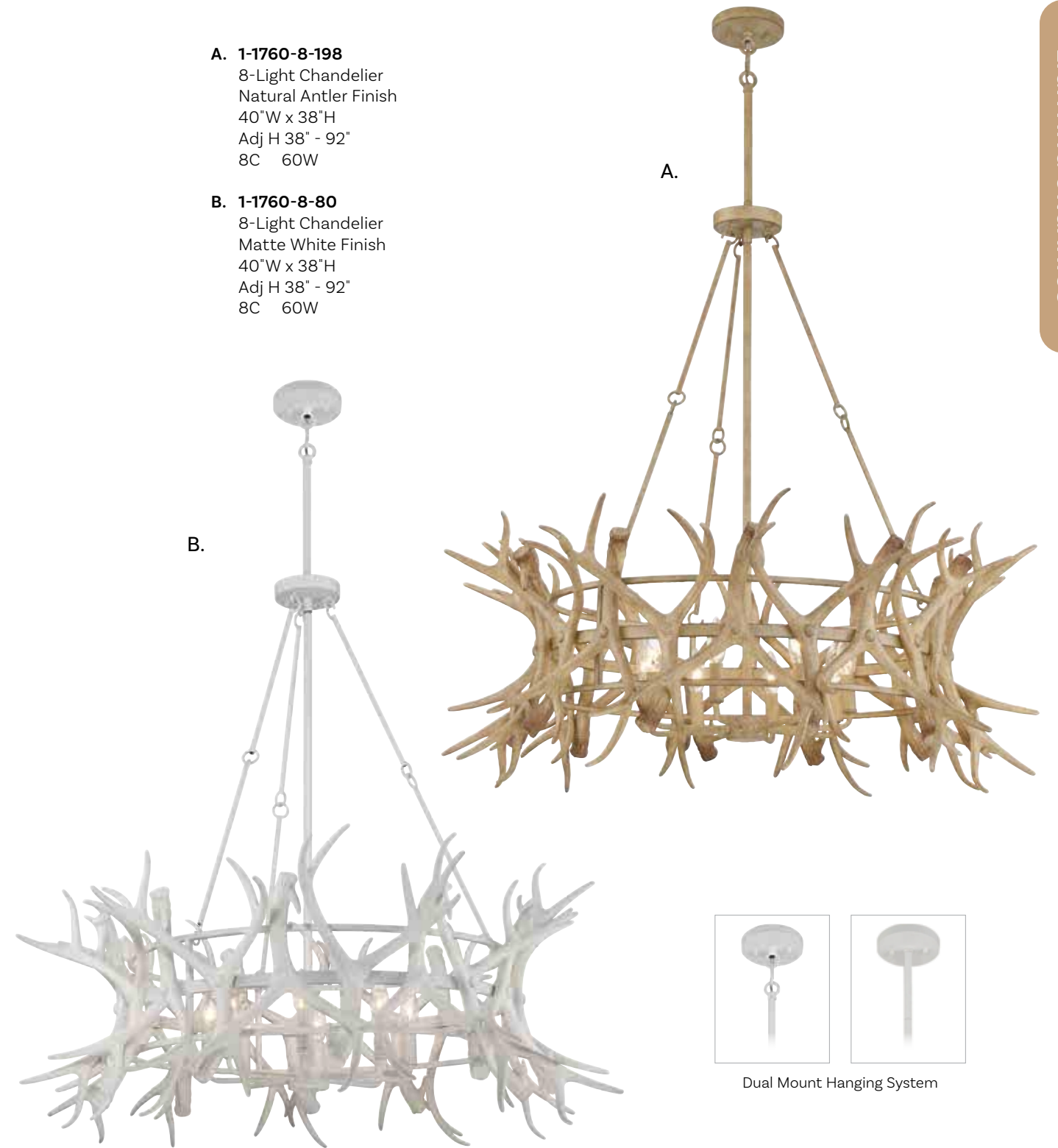

Dual Mount Hanging System

Includes 12" & 6" extensions - additional stems available - 7-EXTLG

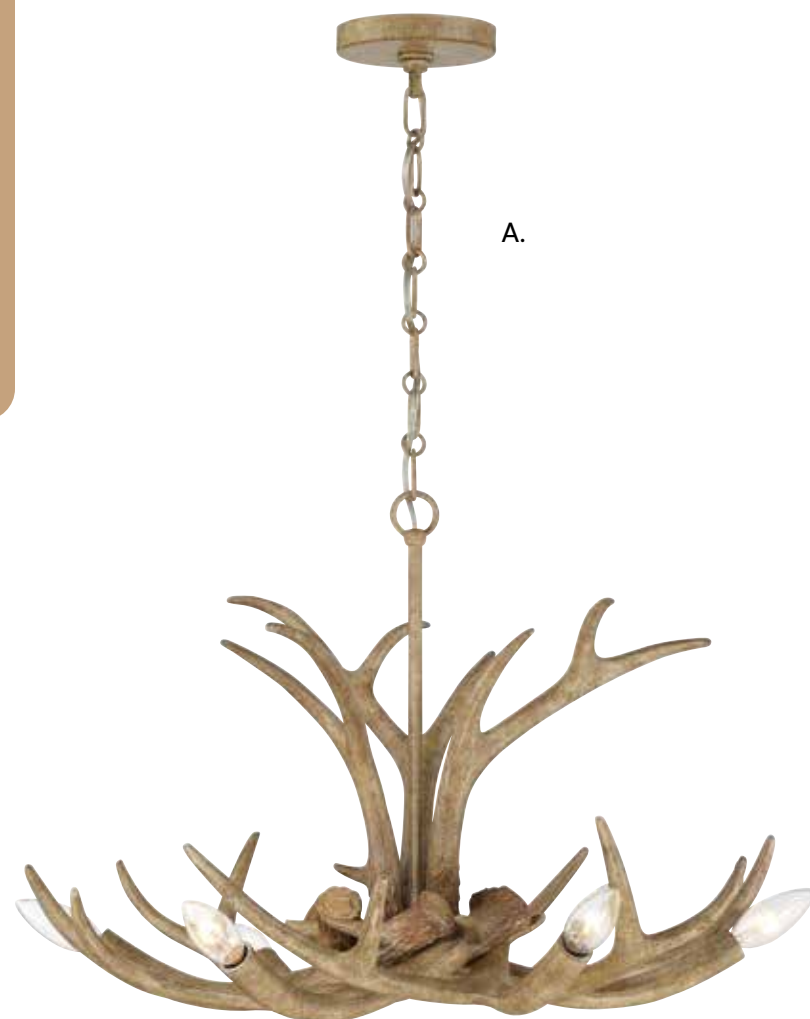

A.

A. 1-1761-6-198
6-Light Chandelier
Natural Antler Finish
24"W x 17"H
6C 60W



B.

B. 1-1761-6-80
6-Light Chandelier
Matte White Finish
24"W x 17H
6C 60W

Includes 120" chain & wire



CYPERAS

CYPERAS

LIGHTING ORGANICS



7-1825-5-320
5-Light Pendant
Warm Brass & Rope Finish
30"W x 22"H
5C 60W

Includes 120" chain & wire



LIGHTING ORGANICS

CHARTER

LIGHTING ORGANICS



CHARTER/CANNON

LIGHTING ORGANICS

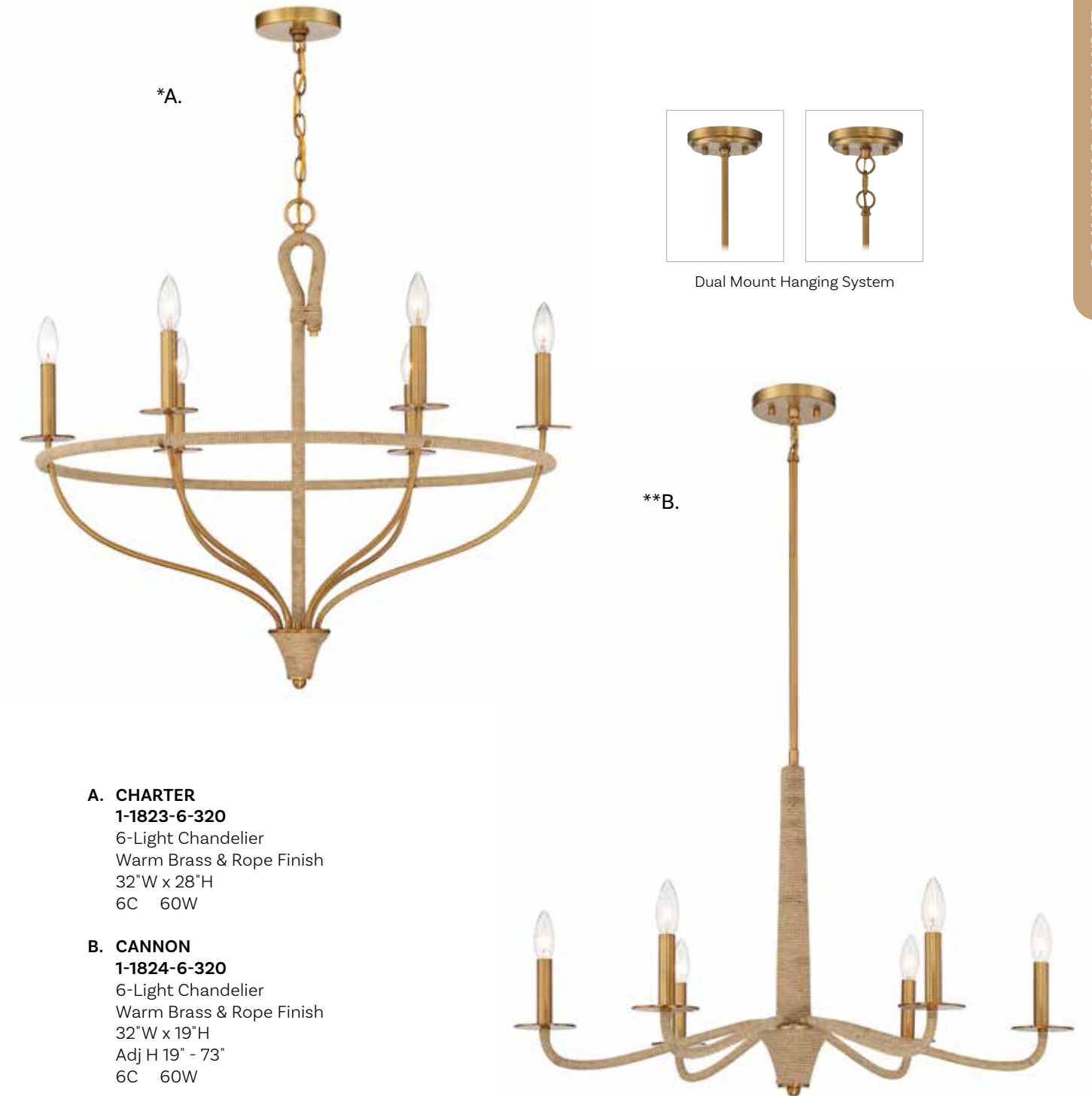

A. CHARTER
1-1823-6-320
 6-Light Chandelier
 Warm Brass & Rope Finish
 32"W x 28"H
 6C 60W

B. CANNON
1-1824-6-320
 6-Light Chandelier
 Warm Brass & Rope Finish
 32"W x 19"H
 Adj H 19" - 73"
 6C 60W

*Includes 120" chain & wire

**Includes 12" & 6" extensions - additional stems available - 7-EXT

ASHBURN

ASHBURN

LIGHTING ORGANICS



LIGHTING ORGANICS

BRIAN THOMAS
COLLECTION

A. 3-1773-6-320
6-Light Pendant
Warm Brass & Rope Finish
16"W x 24-1/2"H
Adj H 24-1/2" - 78-1/2"
6C 60W

B. 7-1774-6-320
6-Light Pendant
Warm Brass & Rope Finish
28"W x 12"H
Adj H 12" - 66"
6C 60W

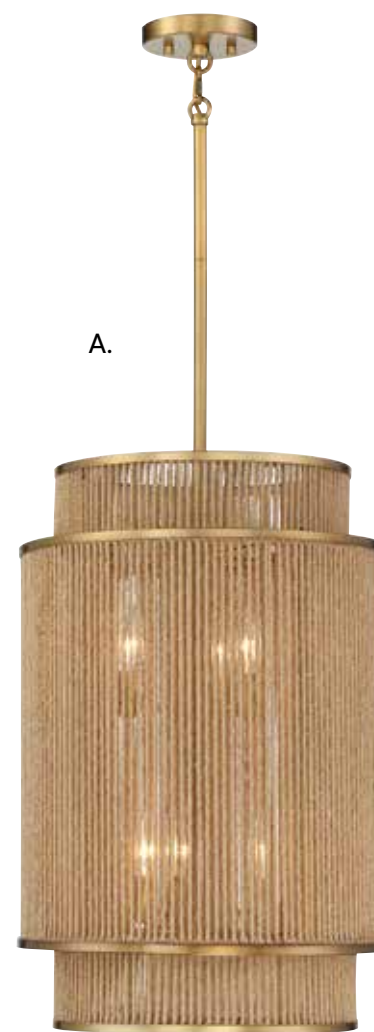

Dual Mount Hanging System

Includes 12" & 6" extensions - additional stems available - 7-EXTLG



A.



B.

A. 6-1682-5-320
 5-Light Semi-Flush
 Warm Brass & Rope Finish
 24"W x 8"H
 5E 60W

B. 9-1826-1-320
 1-Light Sconce
 Warm Brass & Rope Finish
 8-1/2"W x 16"H x 8-1/2"E
 1C 60W
 Clear Glass



*C.

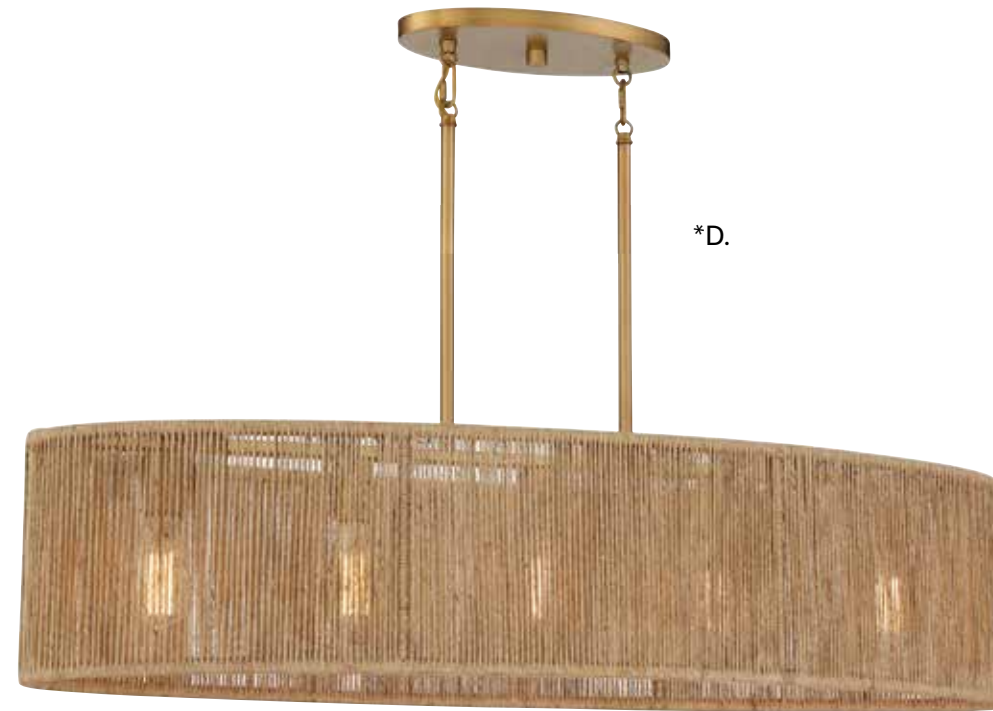

*D.



Dual Mount Hanging System

C. 7-1739-4-320
 4-Light Pendant
 Warm Brass & Rope Finish
 20"W x 8"H
 Adj H 8" - 62"
 4E 60W

D. 1-1738-5-320
 5-Light Oval Chandelier
 Warm Brass & Rope Finish
 42"L x 14"W x 9"H
 Adj H 9" - 63"
 5E 60W

*Includes 12" & 6" extensions - additional stems available - 7-EXTLG



Dual Mount Hanging System

A. 3-1772-6-200
6-Light Foyer
Natural w/
Warm Brass Finish
16"W x 19"H
Adj H 19" - 73"
6C 60W
Cane Shade

B. 7-1771-6-200
6-Light Pendant
Natural w/
Warm Brass Finish
24"W x 13"H
Adj H 13" - 67"
6C 60W
Cane Shade

C. 1-1770-5-200
5-Light Oval Chandelier
Natural w/
Warm Brass Finish
44"L x 20"W x 10"H
Adj H 10" - 64"
5C 60W
Cane Shade

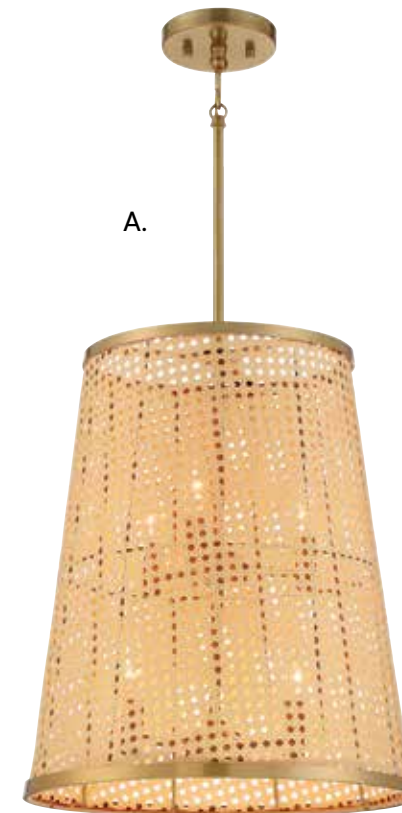

A.



B.

BRIAN THOMAS
COLLECTION

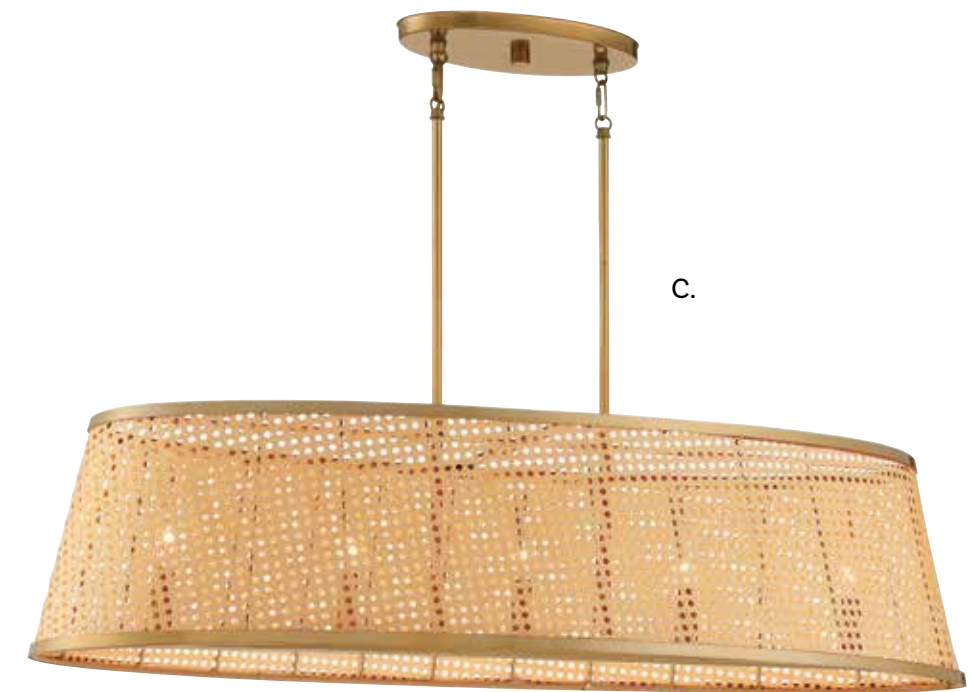

C.

Includes 12" & 6" extensions - additional stems available - **7-EXT**

FAN D'LIER®
ASTORIA

FAN D'LIER®
ASTORIA

LIGHTING ORGANICS

LIGHTING ORGANICS



FAN NUMBER	25-FD-1650-89	25-FD-1650-322
MOTOR FINISH	Matte Black	Warm Brass
SHADE FINISH	Natural Cane	Natural Cane

ENERGY USE AT HIGH SPEED		
Airflow Use	Electricity Use	Airflow Efficiency
1,234 Cu Ft/Min	36W Excludes Lights	34.28 Cu Ft/Min/W
Compare: 36" to 48" ceiling fans have airflow efficiencies ranging from approximately 71 to 86 cu. ft. per min. per watt at high speed.		

- Motor Size 80 x 70
- 14" Blade Span
- 25"W x 11"H (Cage Only)
- 15° Blade Pitch
- Downrods Included 4" & 18"
- Additional Downrod Lengths Sold Separately
- ABS Blades & Integrated Fan Light Included
- 4E 8W LED Dimmable Bulbs
870 Lumens, 3000K, 90+ CRI
- Not Hugger Kit Adaptable
- Handheld Remote Included
(RMT-AC-UNIVERSAL)



Handheld Remote
 Control Included
 RMT-AC-UNIVERSAL

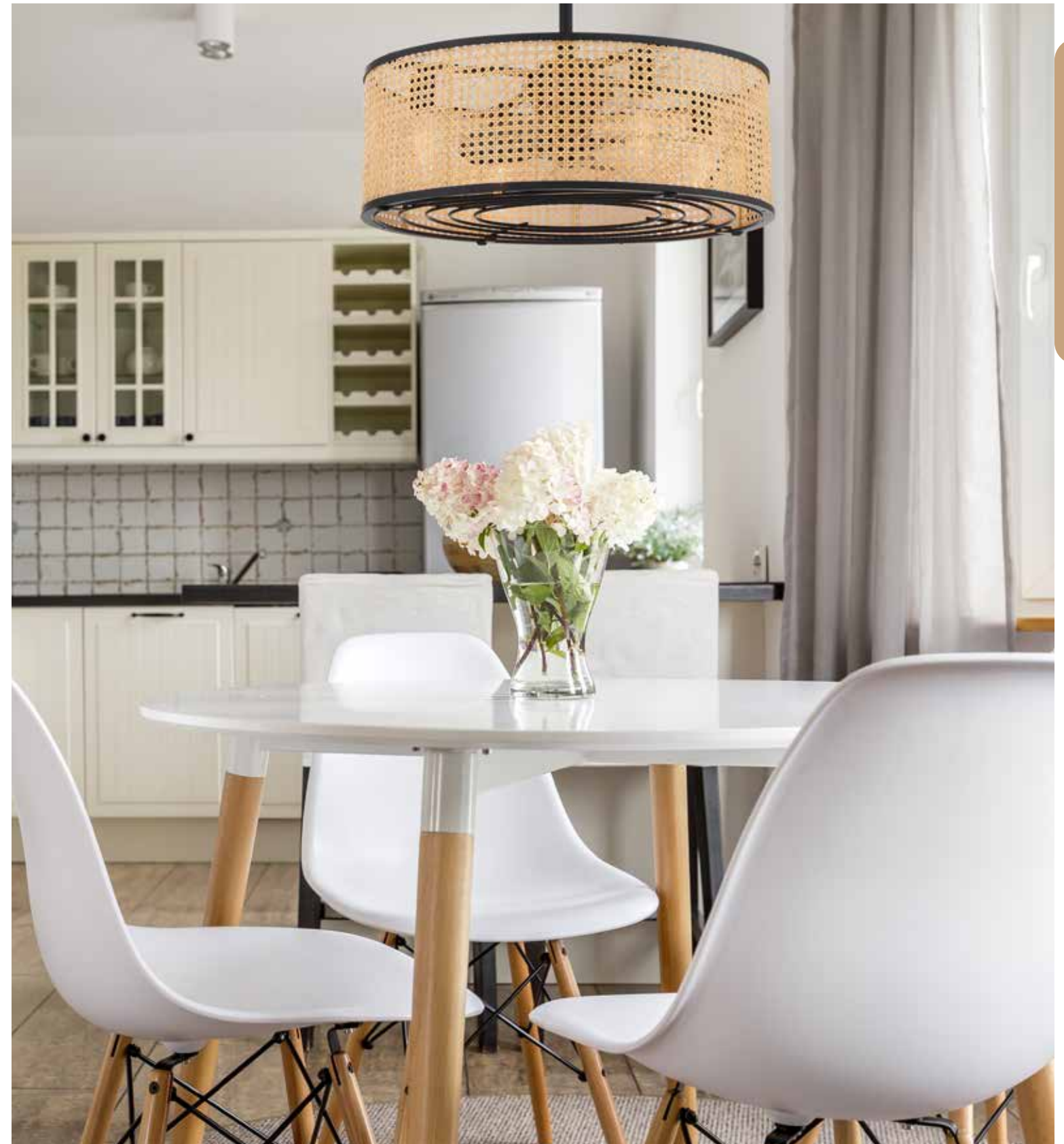



7-7772-6-180
6-Light Pendant
Matte Black w/ Dark Rattan Finish
30"W x 14-5/8"H
6C 60W
Metal Candle Covers

Includes 120" chain & wire





7-1703-6-13
6-Light Pendant
English Bronze Finish
28"W x 30"H
6C 60W
Dark Rattan Shade

Includes 120" chain & wire

MACRA

MACRA/PAMPAS

LIGHTING ORGANICS



LIGHTING ORGANICS

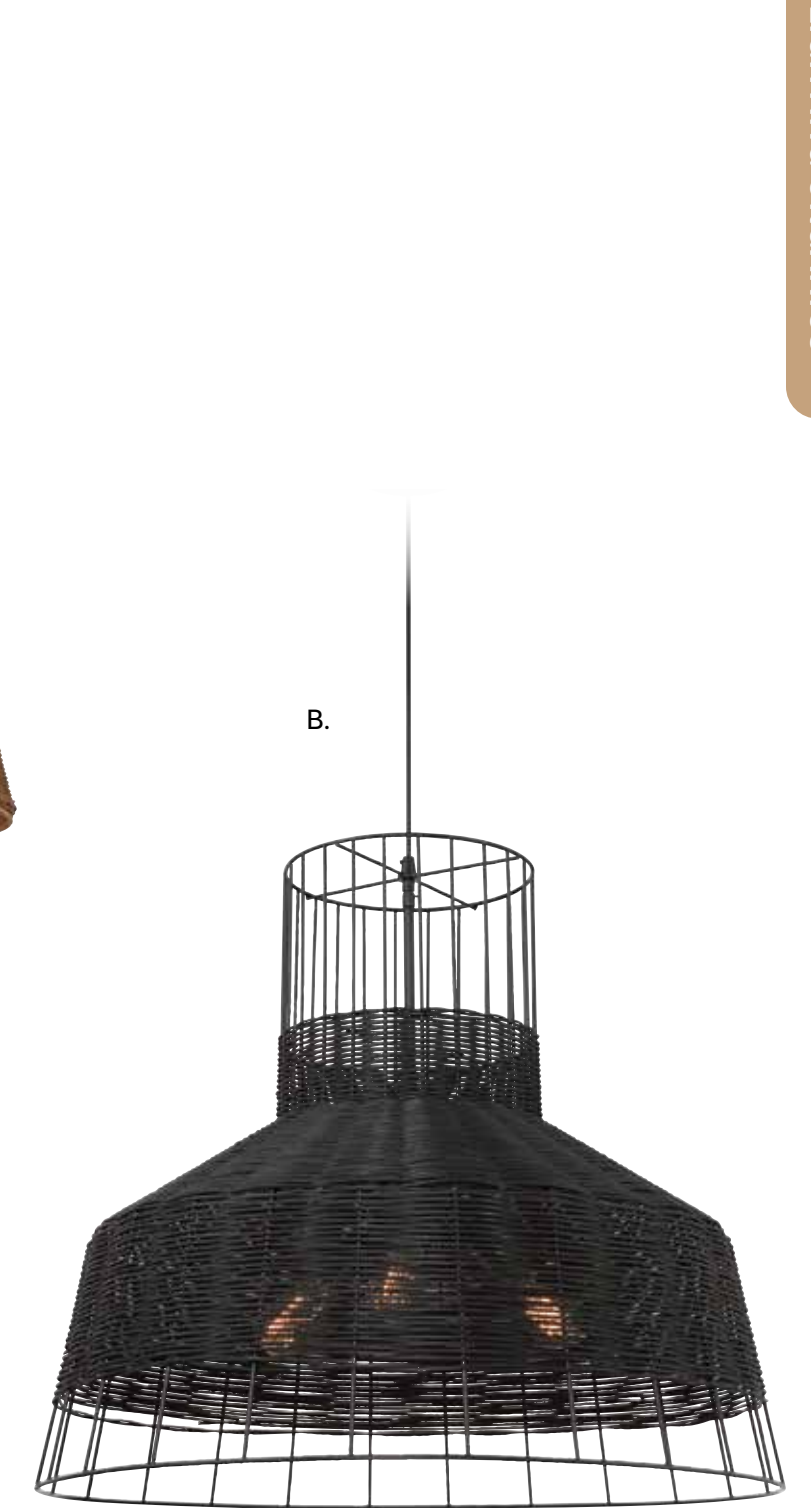
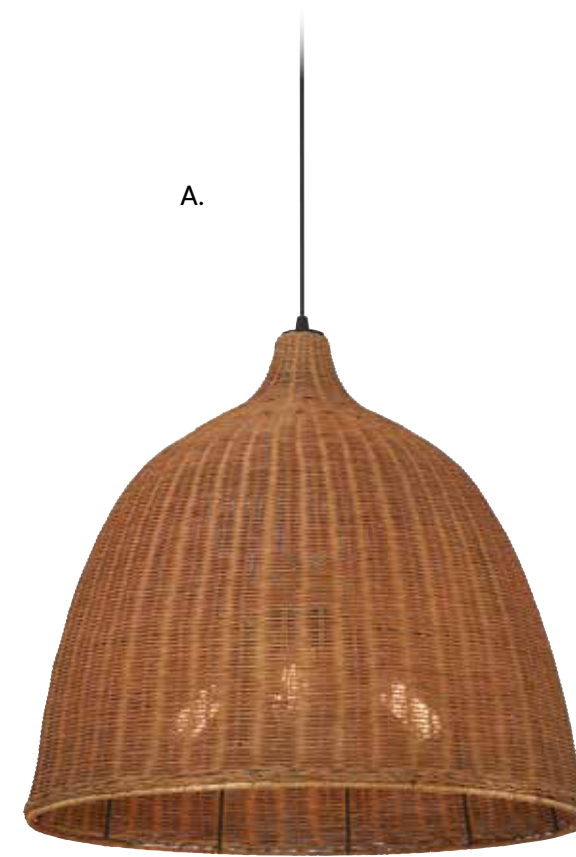

A.

B.

A. MACRA
7-1656-3-128
3-Light Pendant
Café Finish
23"W x 21"H
3E 60W
Wicker Shade

B. PAMPAS
7-1657-3-89
3-Light Pendant
Matte Black Finish
30"W x 26"H
3E 60W
Wicker Shade

Includes 120" lamp cord

BEACON

BEACON

MID-CENTURY

MID-CENTURY



Dual Mount Hanging System

A. 1-181-4-171
 4-Light Pendant
 Burnished Brass Finish
 20"W x 16"H
 Adj H 16" - 70"
 4E 60W
 Frosted White Glass

B. 7-182-3-171
 3-Light Pendant
 Burnished Brass Finish
 12"W x 24"H
 Adj H 24" - 78"
 3C 60W
 Frosted White Glass

C. 9-183-2-171
 2-Light Sconce
 Burnished Brass Finish
 8"W x 16"H x 4"E
 2C 60W
 Frosted White Glass



*A.

*B.

C.

*Includes 12" & 6" extensions - additional stems available - 7-EXT



Dual Mount Hanging System

A.



- A. 1-1590-9-38**
9-Light Chandelier
Royal Gold Finish
20"W x 26-1/2"H
Adj H 26-1/2" - 80-1/2"
9C 60W
Natural Alabaster Stone

- B. 1-1591-14-38**
14-Light Linear Chandelier
Royal Gold Finish
10"W x 10-1/4"H x 48"L
Adj H 10-1/4" - 64-1/4"
14C 60W
Natural Alabaster Stone

B.

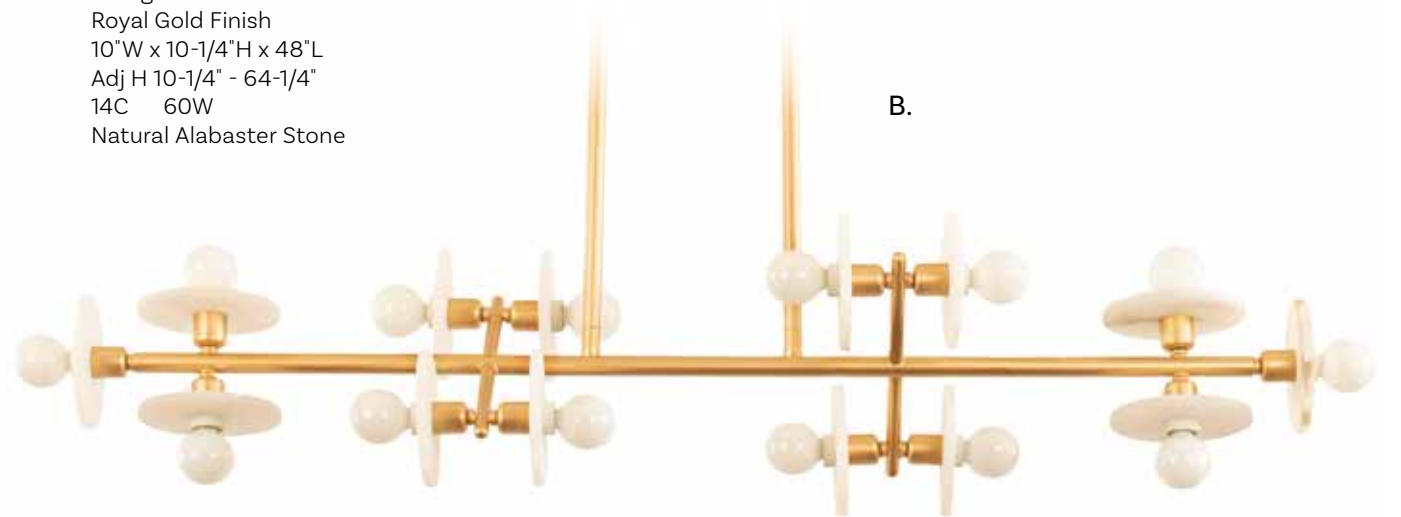

Includes 12" & 6" extensions - additional stems available - 7-EXTLG



Dual Mount Hanging System

A.



- A. 1-1590-9-50**
9-Light Chandelier
Black Cashmere Finish
20"W x 26-1/2"H
Adj H 26-1/2" - 80-1/2"
9C 60W
Natural Alabaster Stone

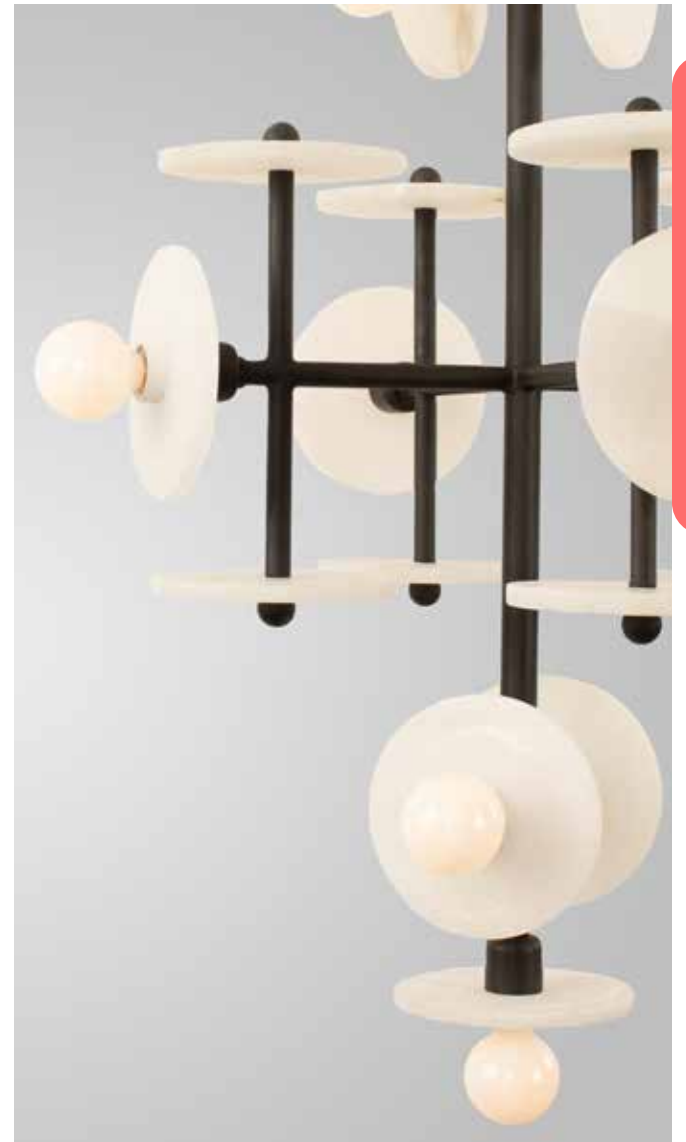

B.

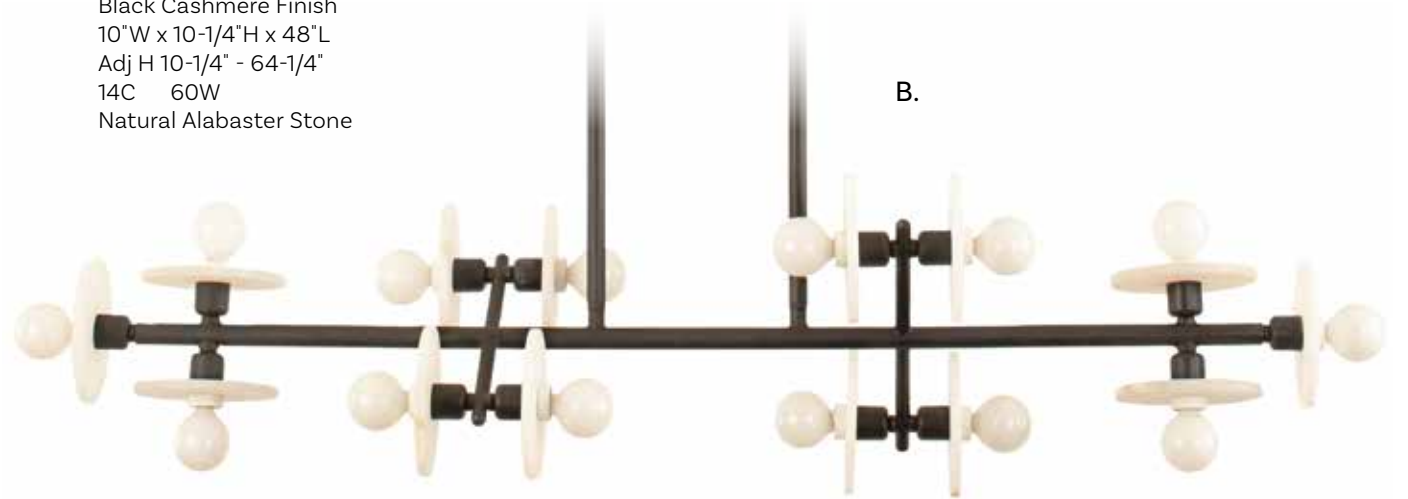

- B. 1-1591-14-50**
14-Light Linear Chandelier
Black Cashmere Finish
10"W x 10-1/4"H x 48"L
Adj H 10-1/4" - 64-1/4"
14C 60W
Natural Alabaster Stone

Includes 12" & 6" extensions - additional stems available - 7-EXTLG

CONTESSA

MID-CENTURY



CONTESSA

MID-CENTURY

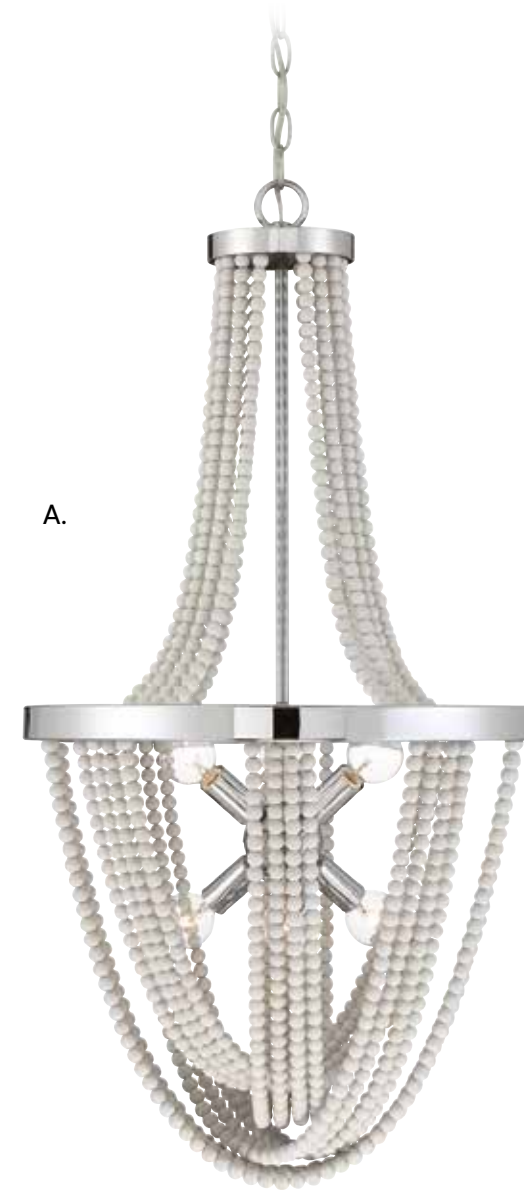

A.

A. 1-1765-6-110
6-Light Chandelier
Polished Chrome w/
Wooden Beads
18"W x 33-1/2"H
6C 60W

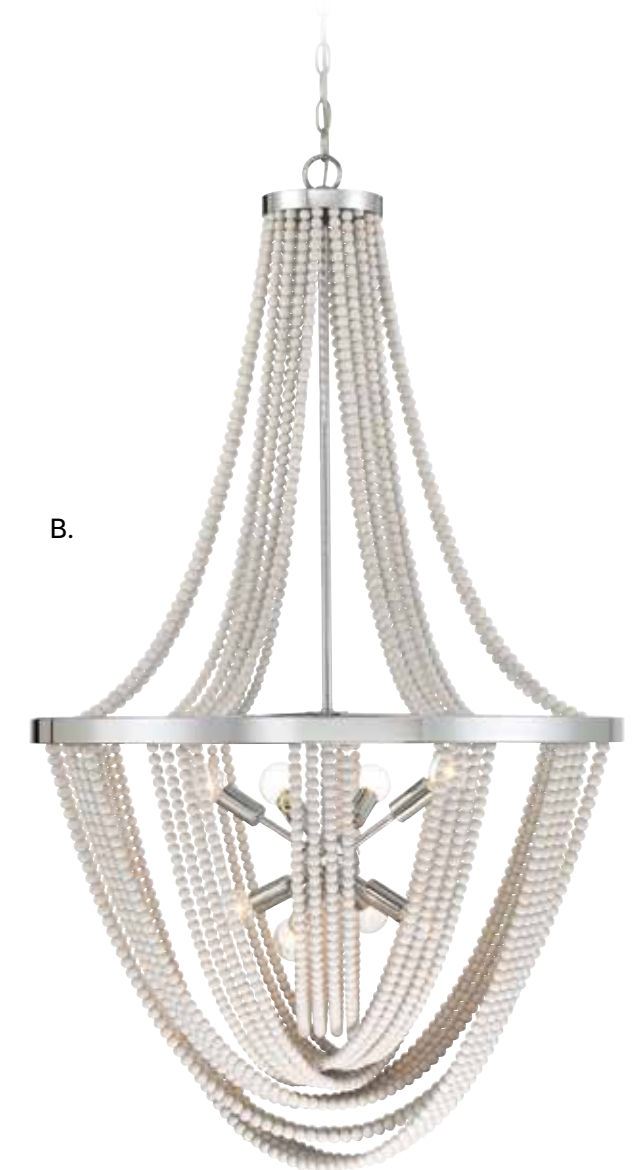

B.

B. 1-1766-8-110
8-Light Chandelier
Polished Chrome w/
Wooden Beads
27"W x 45-1/2"H
8C 60W

Includes 120" chain & wire

ARIEL

ARIEL

MID-CENTURY

MID-CENTURY

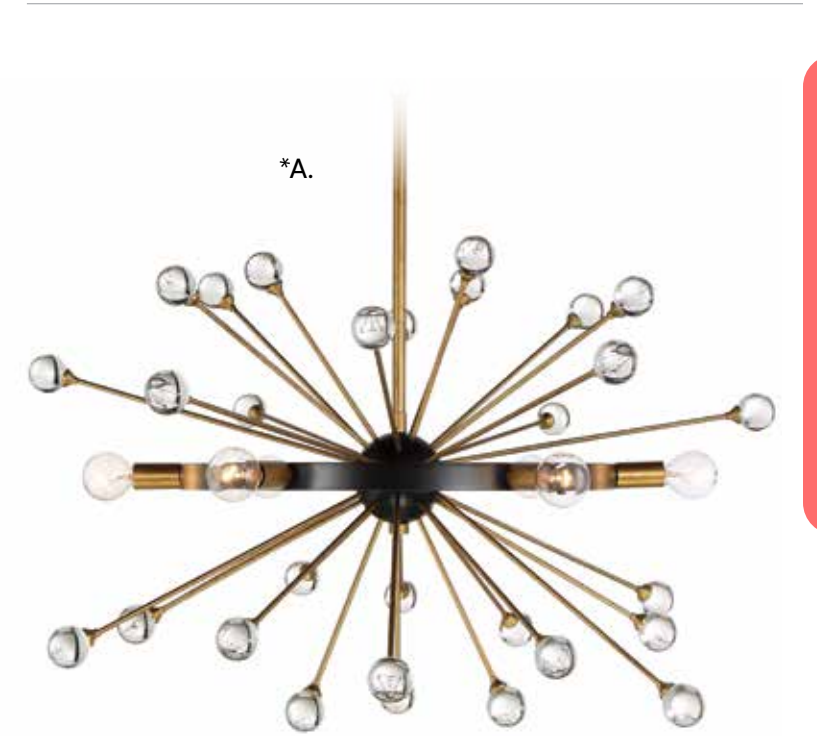
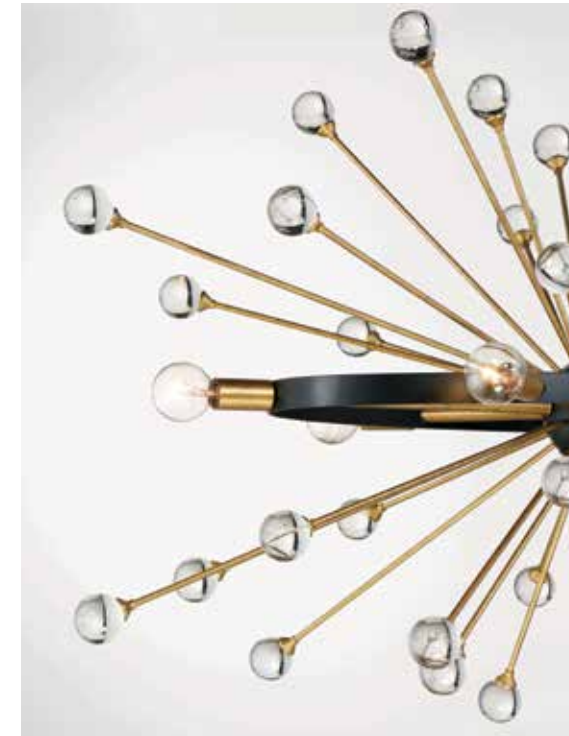

Dual Mount Hanging System

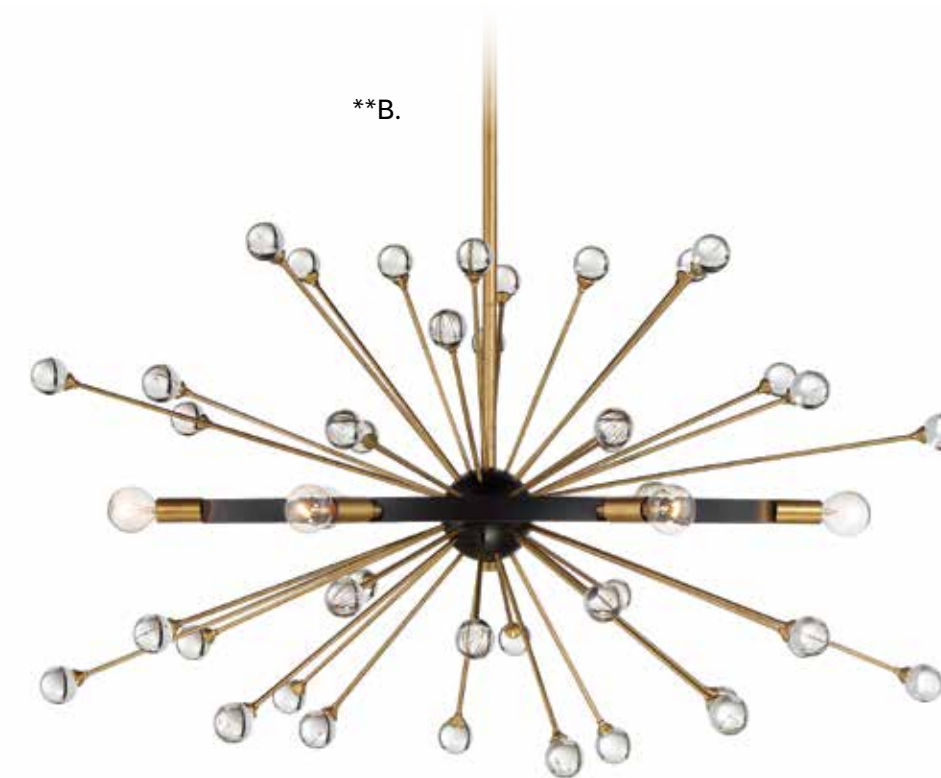

- A. 1-1857-6-62**
6-Light Chandelier
Como Black w/ Gold Accents
25"W x 18"H
Adj H 18" - 72"
6C 60W
Clear Crystal
- B. 1-1858-6-62**
6-Light Oval Chandelier
Como Black w/ Gold Accents
37"L x 18"W x 21"H
Adj H 21" - 75"
6C 60W
Clear Crystal

*Includes 12" & 6" extensions - additional stems available - 7-EXT

**Includes 12" & 6" extensions - additional stems available - 7-EXTLG

COUPLER

COUPLER

MID-CENTURY

MID-CENTURY



A. 1-6697-4-143
4-Light Chandelier
Matte Black w/
Warm Brass Finish
16"W x 22"H
Adj H 22" - 76"
4G9 60W
Frosted Glass
G9 Bulbs Included

B. 1-6698-8-143
8-Light Chandelier
Matte Black w/
Warm Brass Finish
25"W x 21"H
Adj H 21" - 75"
8G9 60W
Frosted Glass
G9 Bulbs Included

C. 1-6699-8-143
8-Light Linear Chandelier
Matte Black w/
Warm Brass Finish
10"W x 13"H x 38" L
Adj H 13" - 67"
8G9 60W
Frosted Glass
G9 Bulbs Included



Sconce, Page 270

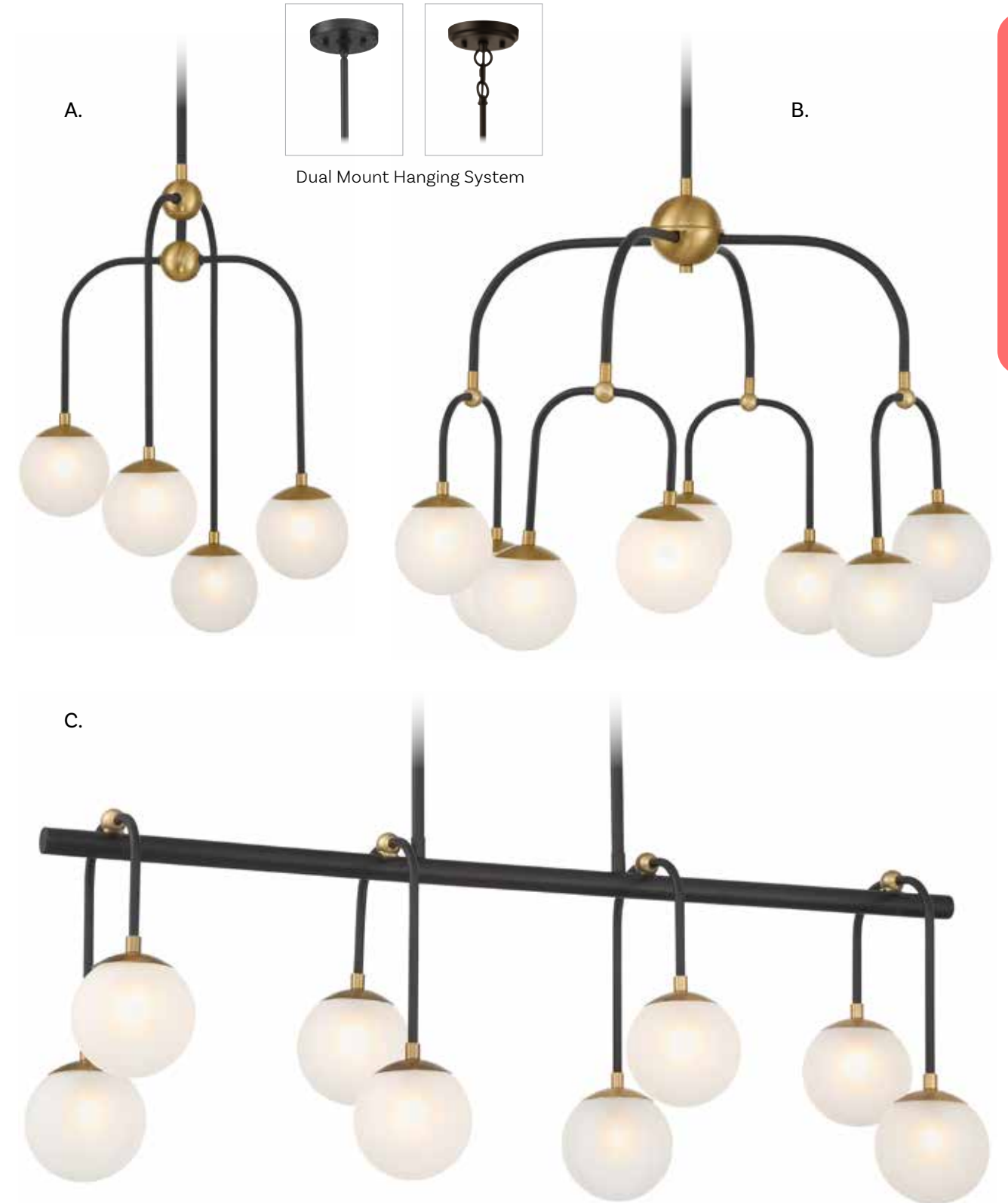

Includes 12" & 6" extensions - additional stems available - 7-EXT

ARCHWAY

ARCHWAY

MID-CENTURY

MID-CENTURY



Dual Mount Hanging System

A. 9-5531-2-143
2-Light Sconce
Warm Brass w/
Matte Black Finish
9"W x 12-1/2"H x 4"E
2C 60W

B. 7-5532-4-143
4-Light Chandelier
Warm Brass w/
Matte Black Finish
14"W x 18"H
Adj H 18" - 72"
4C 60W

C. 1-5533-8-143
8-Light Linear Chandelier
Warm Brass w/
Matte Black Finish
10"W x 12-1/2"H x 38"L
Adj H 12-1/2" - 66-1/2"
8C 60W

A.



*B.



*C.



*Includes 12" & 6" extensions - additional stems available - 7-EXT



Dual Mount Hanging System

A. 9-1792-15-89
LED Sconce
Matte Black Finish
8-1/2"W x 16"H x 4"E
15.5W Dimmable LED
520 Lumens,
3000K, 90+ CRI
Clear Crystal

B. 3-1791-22-89
LED Pendant
Matte Black Finish
14"W x 18"H
Adj H 18" - 72"
22W Dimmable LED
893 Lumens,
3000K, 90+ CRI
Clear Crystal

C. 1-1790-36-89
LED Linear Chandelier
Matte Black Finish
38"L x 11-1/2"W x 11"H
Adj H 11" - 65"
36W Dimmable LED
1817 Lumens,
3000K, 90+ CRI
Clear Crystal



A.



*B.



*C.

LED

*Includes 12" & 6" extensions - additional stems available - 7-EXT

DEXTER

MID-CENTURY



A. 7-2241-3-67
3-Light Pendant
Matte Black w/
Polished Chrome Accents
21"W x 24"H
Adj H 24" - 78"
3E 60W
30° Swivel



*Includes 12" & 6" extensions - additional stems available - 7-EXT

FOLSOM

MID-CENTURY

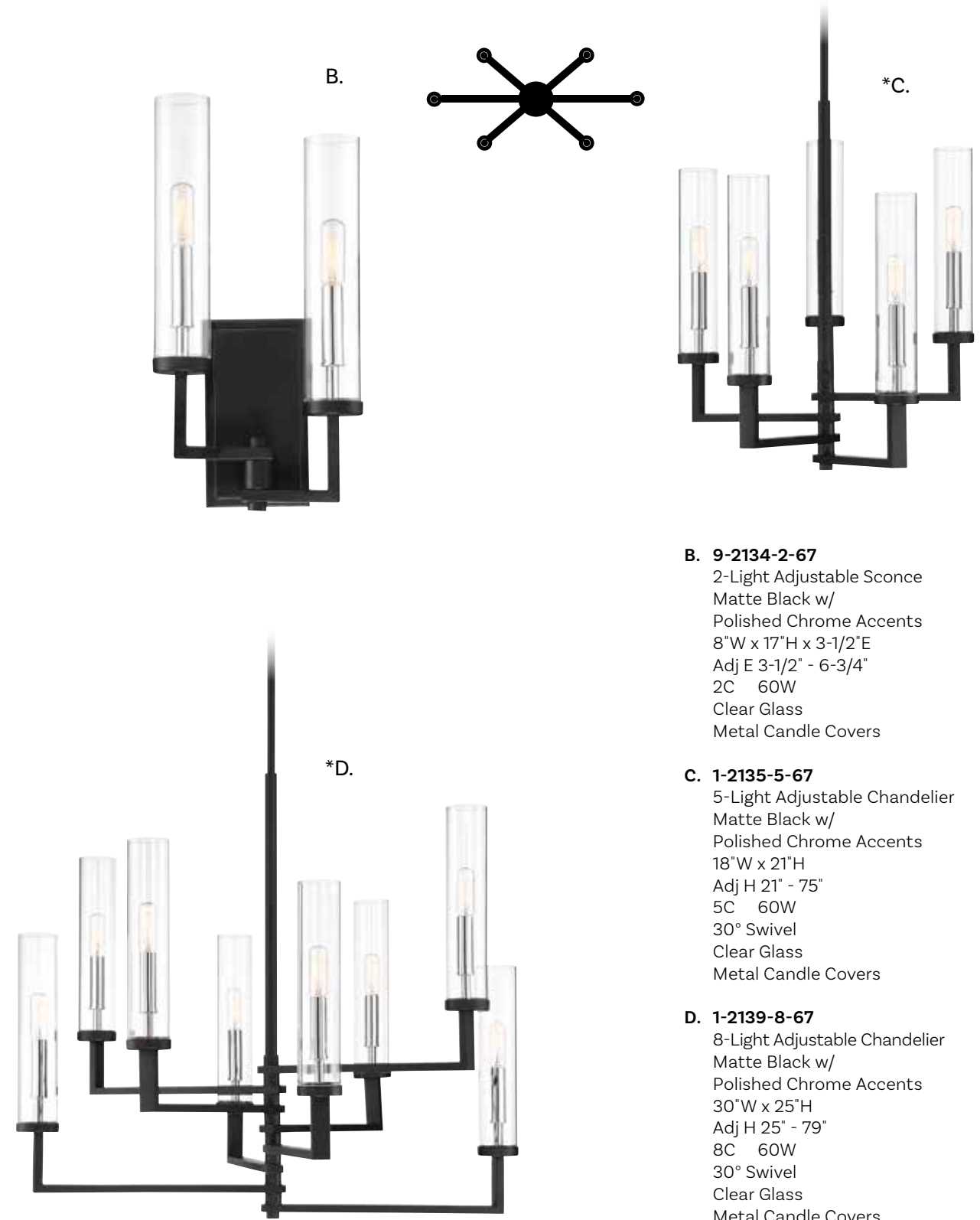

B. 9-2134-2-67
2-Light Adjustable Sconce
Matte Black w/
Polished Chrome Accents
8"W x 17"H x 3-1/2"E
Adj E 3-1/2" - 6-3/4"
2C 60W
Clear Glass
Metal Candle Covers

C. 1-2135-5-67
5-Light Adjustable Chandelier
Matte Black w/
Polished Chrome Accents
18"W x 21"H
Adj H 21" - 75"
5C 60W
30° Swivel
Clear Glass
Metal Candle Covers

D. 1-2139-8-67
8-Light Adjustable Chandelier
Matte Black w/
Polished Chrome Accents
30"W x 25"H
Adj H 25" - 79"
8C 60W
30° Swivel
Clear Glass
Metal Candle Covers

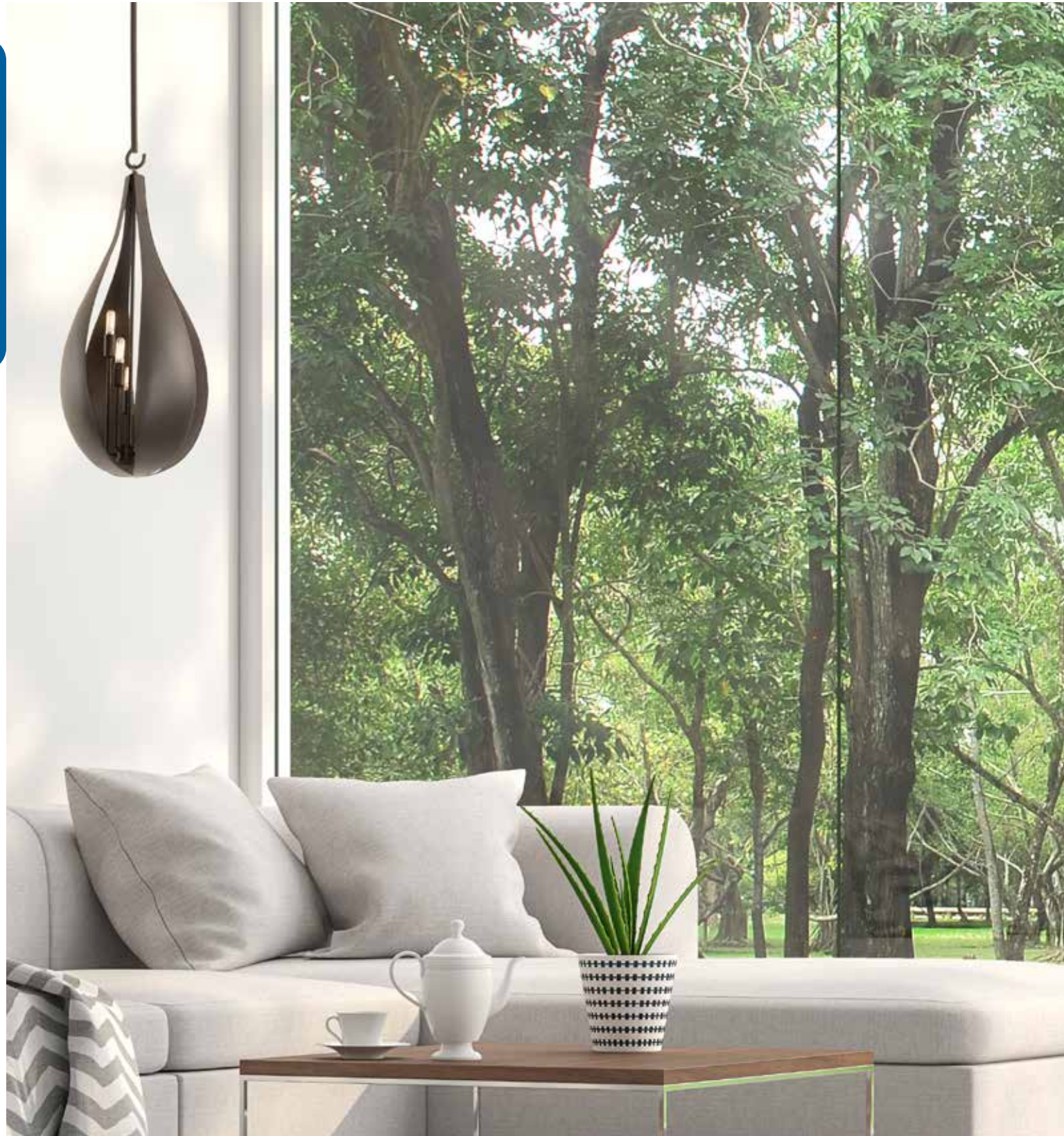

Dual Mount Hanging System



A. 3-4390-5-50
5-Light Pendant
Black Cashmere Finish
12"W x 31"H
Adj H 31" - 85"
5C 60W

B. 3-4391-6-50
6-Light Pendant
Black Cashmere Finish
16"W x 36"H
Adj H 36" - 90"
6C 60W

C. 3-4390-5-47
5-Light Pendant
White Cashmere Finish
12"W x 31"H
Adj H 31" - 85"
5C 60W

D. 3-4391-6-47
6-Light Pendant
White Cashmere Finish
16"W x 36"H
Adj H 36" - 90"
6C 60W

Includes 12" & 6" extensions - additional stems available - 7-EXTLG

*A.



*B.

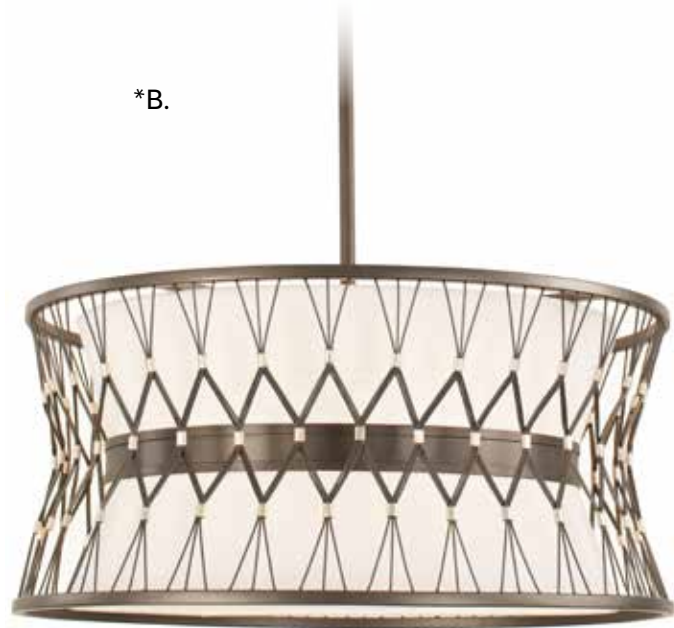

C.



Dual Mount Hanging System

A. 3-8811-6-92
6-Light Foyer
Rumba Finish
16"W x 28"H
Adj H 28" - 82"
6C 60W
White Fabric Shade

B. 7-8810-6-92
6-Light Pendant
Rumba Finish
22"W x 12"H
Adj H 12" - 66"
6C 60W
White Fabric Shade

C. 9-8812-2-92
2-Light Sconce
Rumba Finish
6"W x 14"H x 5-1/4"E
2C 60W
White Fabric Shade

*Includes 12" & 6" extensions - additional stems available - 7-EXTLG



*Includes 12" decorative linked stem, plus 120" chain

**Includes 14-1/2" decorative linked stem, plus 120" chain

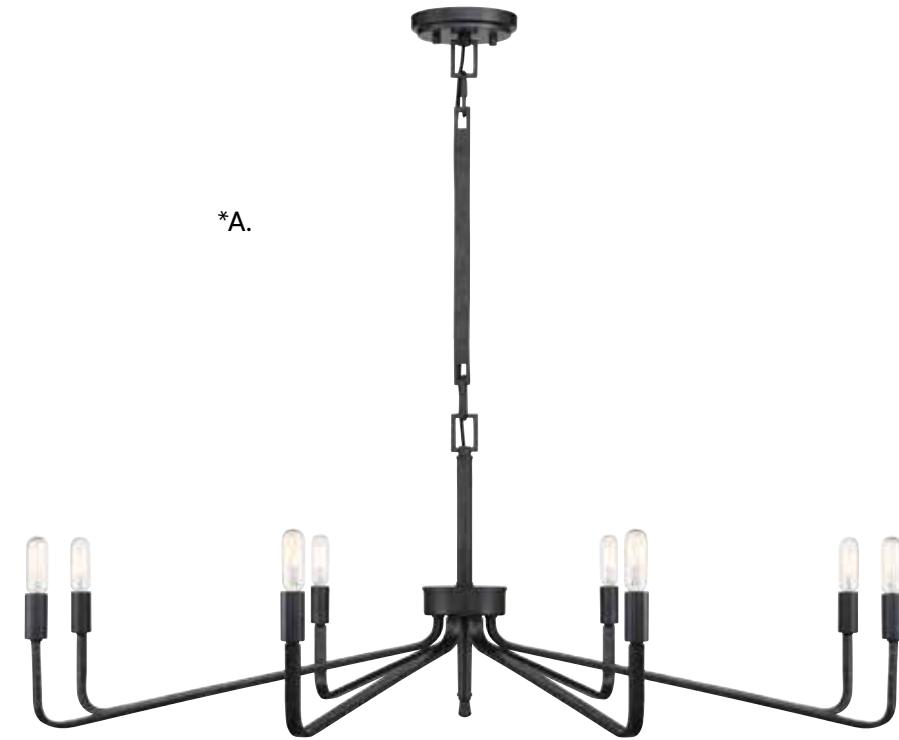

*A.

A. 1-6400-8-190
8-Light Chandelier
Forged Iron Finish
40"W x 14"H
8C 60W
Metal Candle Covers

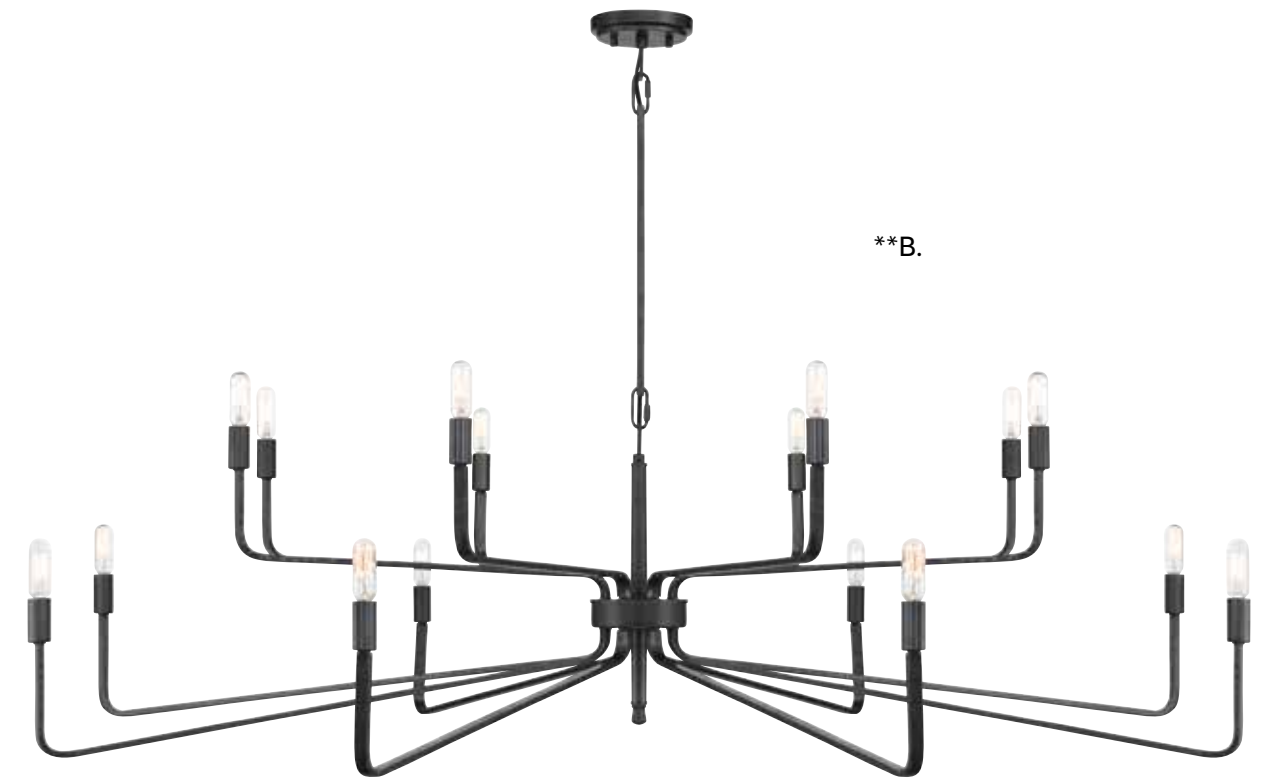

**B.

B. 1-6402-16-190
16-Light Chandelier
Forged Iron Finish
57"W x 18"H
16C 60W
Metal Candle Covers

LARAMIE

LARAMIE

CASUAL SOPHISTICATION

CASUAL SOPHISTICATION

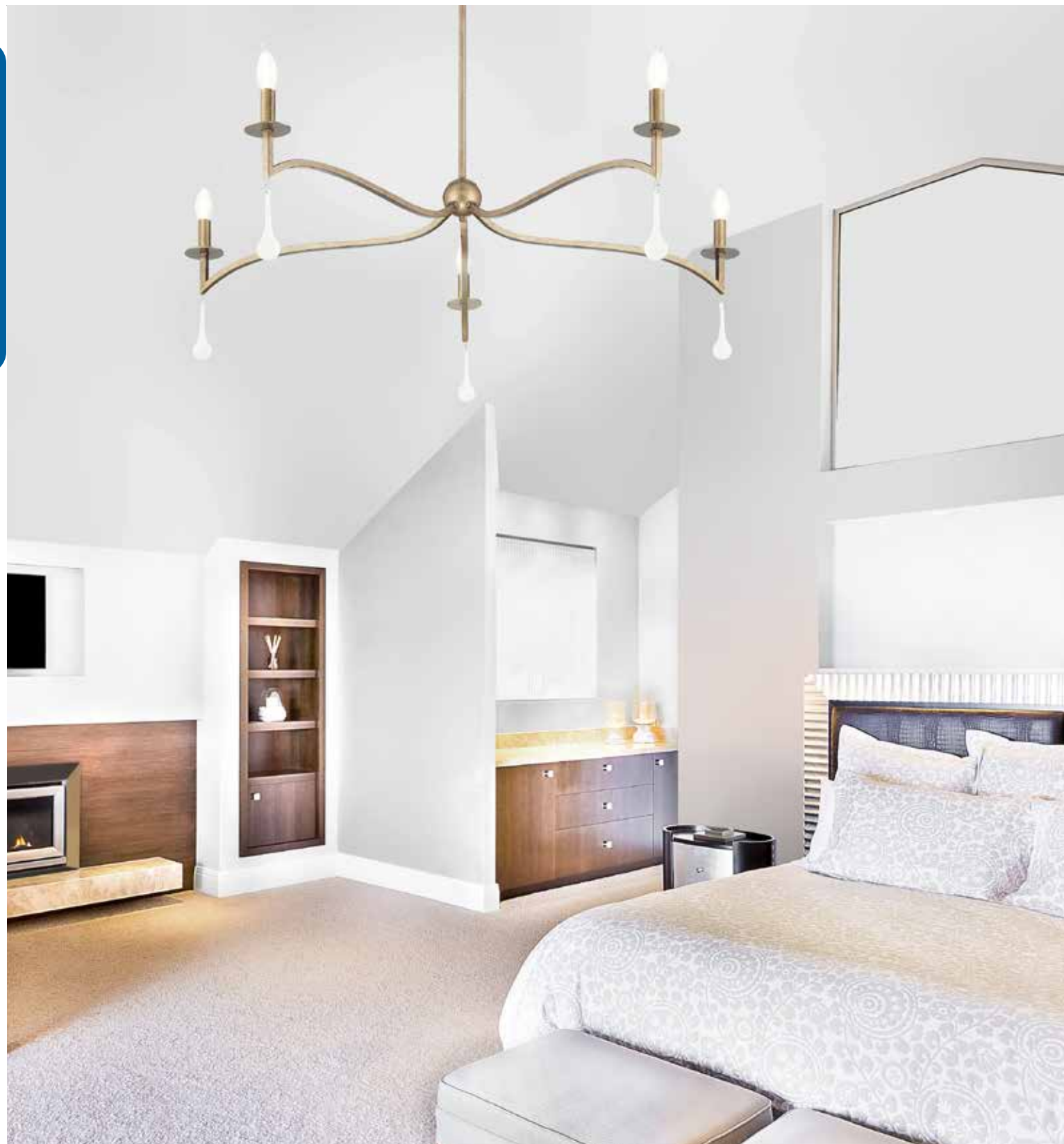

Dual Mount Hanging System

A. 1-1099-5-182
 5-Light Chandelier
 Chelsea Gold Finish
 43"W x 12"H
 Adj H 12"- 66"
 5C 60W
 Frosted Crystal Accents

B. 1-1099-5-183
 5-Light Chandelier
 Chelsea Walnut Finish
 43"W x 12"H
 Adj H 12"- 66"
 5C 60W
 Frosted Crystal Accents

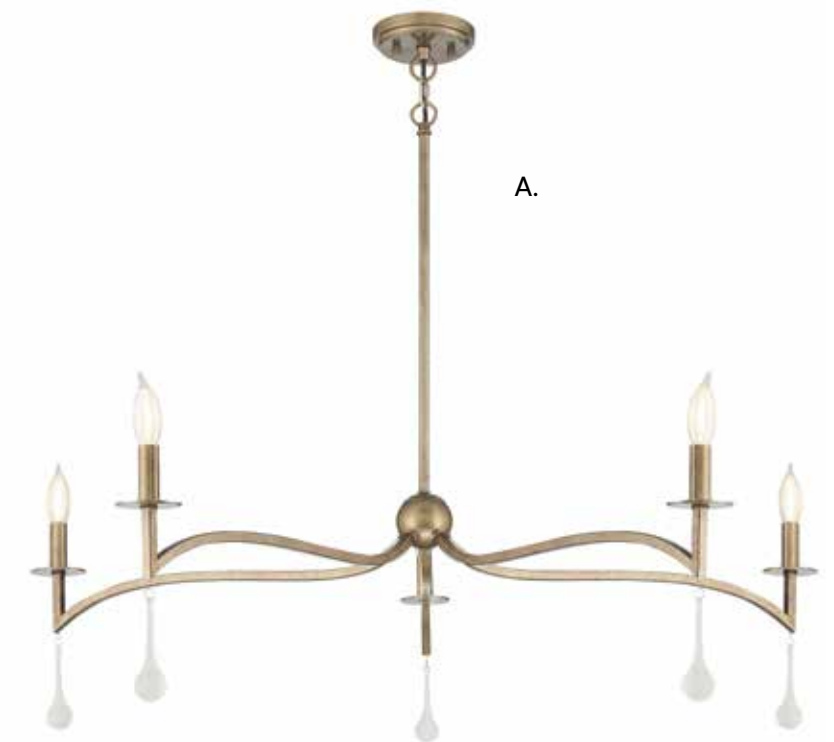

A.

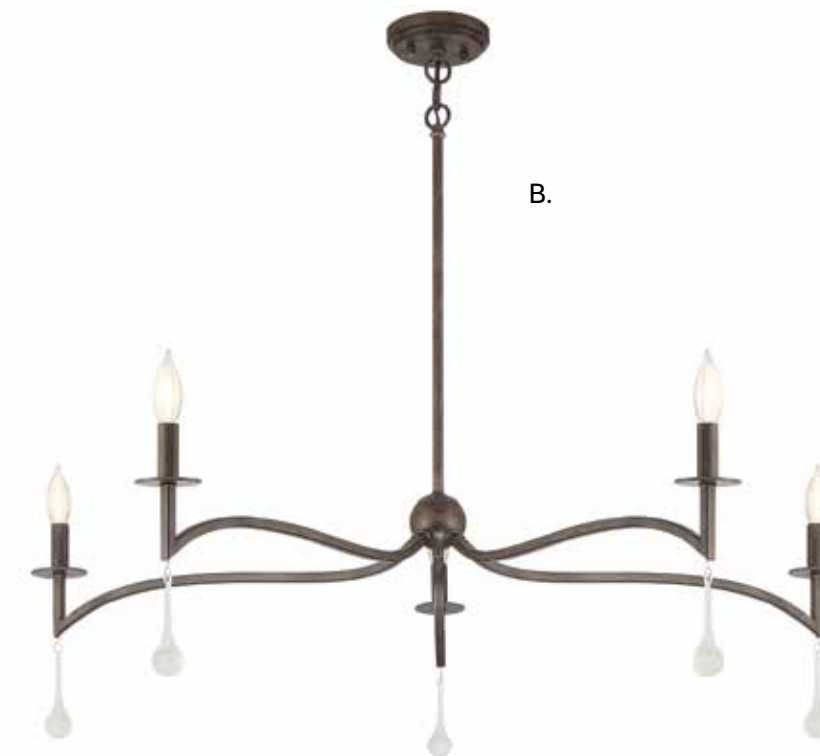

B.



Pendant, Page 226

*Includes 12" & 6" extensions - additional stems available - 7-EXT



A. 7-804-1-02
1-Light Mini-Pendant
Oiled Bronze Finish
9-1/2"W x 25"H
Adj H 25" - 53-1/2"
1E 60W
Clear Glass

B. 1-801-5-02
5-Light Chandelier
Oiled Bronze Finish
23"W x 13-1/2"H
5E 60W
Clear Glass

C. 1-803-3-02
3-Light Linear Chandelier
Oiled Bronze Finish
42"L x 7-3/4"W x 26-1/4"H
3E 60W
Clear Glass



*Includes 9-1/2" extensions - additional stems available - **7-EXT**

**Includes 120" lamp cord

***Includes 120" chain & wire

A.



A. 1-1838-6-322
6-Light Chandelier
Warm Brass Finish
29"W x 27"H
6E 60W
Seeded Glass
Chocolate Leather

B. 1-1838-6-154
6-Light Chandelier
Antique Nickel Finish
29"W x 27"H
6E 60W
Seeded Glass
Charcoal Leather

B.



Includes 120" chain & wire





Includes 120" chain & wire



A.



B.



C.

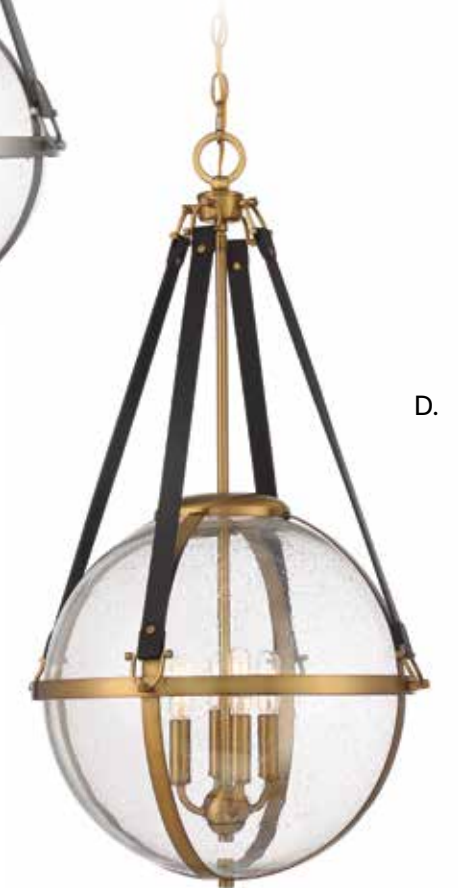

D.

A. 7-1836-4-154
4-Light Pendant
Antique Nickel Finish
18"W x 32-1/2"H
4C 60W
Seeded Glass
Charcoal Leather

B. 7-1837-3-154
3-Light Pendant
Antique Nickel Finish
14"W x 25"H
3C 60W
Seeded Glass
Charcoal Leather

C. 7-1837-3-322
3-Light Pendant
Warm Brass Finish
14"W x 25"H
3C 60W
Seeded Glass
Chocolate Leather

D. 7-1836-4-322
4-Light Pendant
Warm Brass Finish
18"W x 32-1/2"H
4C 60W
Seeded Glass
Chocolate Leather

CHAUCER

CHAUCER

CASUAL SOPHISTICATION



CASUAL SOPHISTICATION



Dual Mount Hanging System

A.



B.



- A. 1-1715-8-154**
8-Light Chandelier
Antique Nickel Finish
30"W x 15"H
Adj H 15" - 69"
8C 60W
Charcoal Leather Accents
Metal Candle Covers

- B. 1-1716-8-322**
8-Light Chandelier
Warm Brass Finish
30"W x 15"H
Adj H 15" - 69"
8C 60W
Chocolate Leather Accents
Metal Candle Covers

Includes 12" & 6" extensions - additional stems available - 7-EXT

PEARL

PEARL

CASUAL SOPHISTICATION

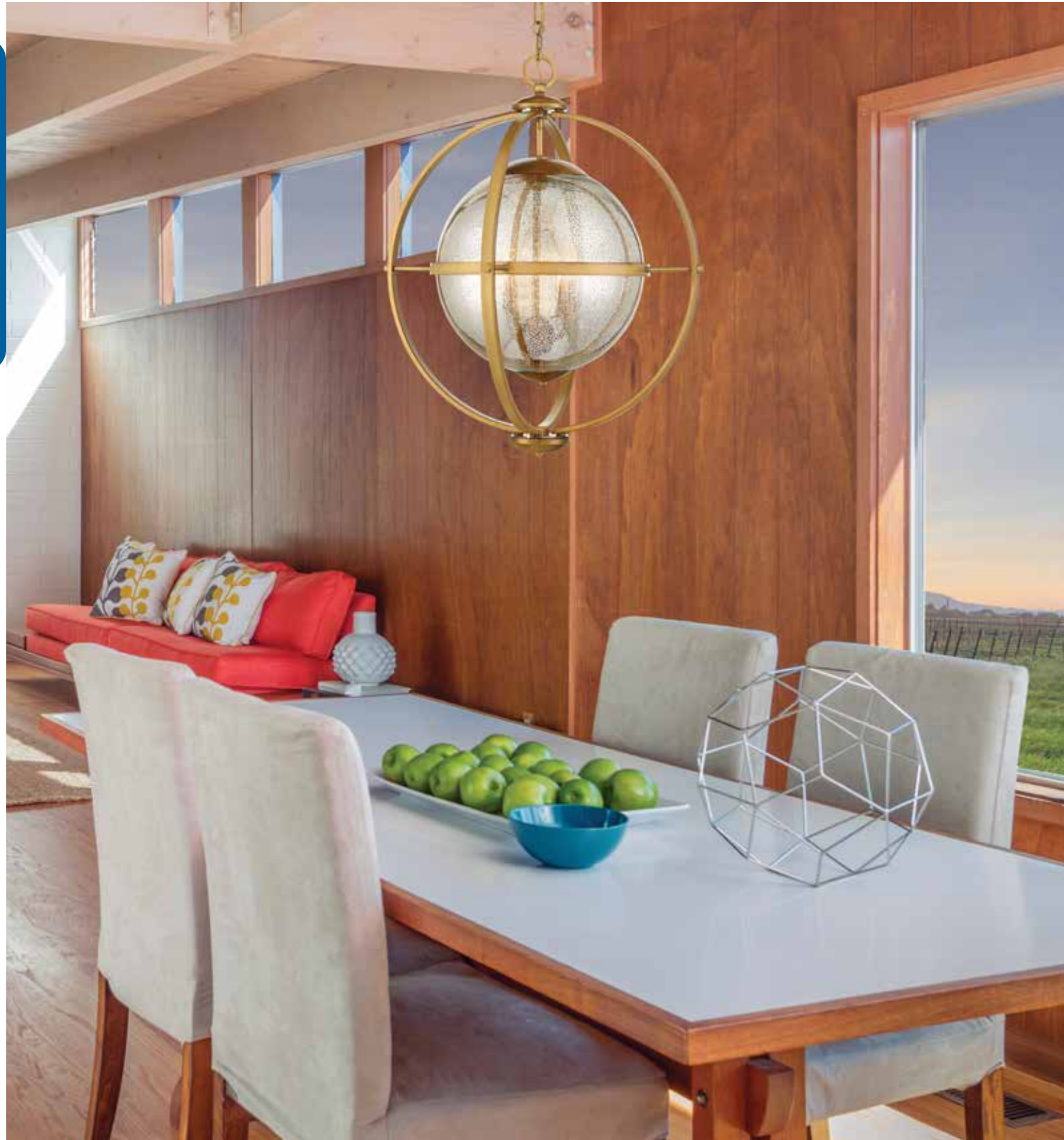

Includes 120" chain & wire

CASUAL SOPHISTICATION

- A. 7-1872-3-28**
3-Light Pendant
Oiled Burnished Bronze Finish
21"W x 24"H
3C 60W
Dark Mercury Glass

- B. 7-1872-3-322**
3-Light Pendant
Warm Brass Finish
21"W x 24"H
3C 60W
Mercury Glass

A.



B.



MALLORY

CASUAL SOPHISTICATION



BRIAN THOMAS
COLLECTION

A.



A. 7-7406-5-39
5-Light Pendant
Fossil Stone Finish
30"W x 30"H
5C 60W
Soft White Beeswax Candle Covers
Wooden Beads / Glass Beads

Includes 120" chain & wire

PANOLA

CASUAL SOPHISTICATION



B.

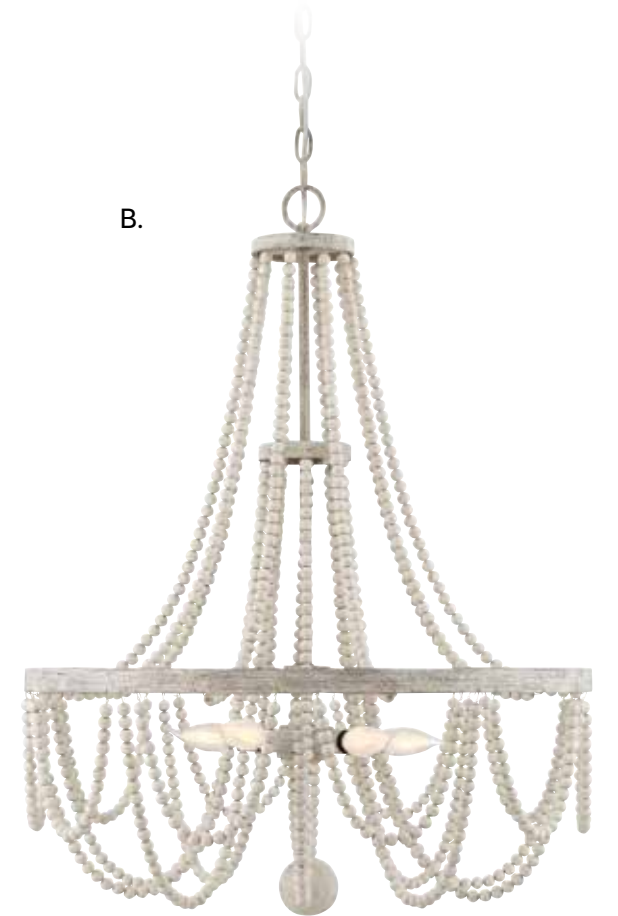

B. 1-9995-5-99
5-Light Chandelier
Provence Finish
24"W x 30"H
5C 60W
Wooden Beads

HASTING

HASTING

CASUAL SOPHISTICATION

CASUAL SOPHISTICATION



**A.

*B.



Dual Mount Hanging System

A. 7-8893-4-101
 4-Light Pendant
 Noblewood w/ Iron Finish
 14"W x 19"H
 4C 60W
 Metal Candle Covers

B. 1-8892-5-101
 5-Light Linear Chandelier
 Noblewood w/ Iron Finish
 42"L x 10"W x 12"H
 Adj H 12"- 66"
 5E 60W

*Includes 12" & 6" extensions - additional stems available - 7-EXT

**Includes 120" chain & wire



A. 1-991-8-41
8-Light Chandelier
Durango Finish
22"W x 36-1/2"H
8E 60W

B. 1-990-8-41
8-Light Linear Chandelier
Durango Finish
42"L x 5"W x 38-1/4"H
8E 60W



Includes 120" chain & wire

Bath, Page 314



Dual Mount Hanging System

A. 1-1805-10-109
 10-Light Chandelier
 Polished Nickel Finish
 60-1/2"W x 32"H
 Adj H 32" - 86"
 10C 60W
 Metal Candle Covers
 Clear Crystal

B. 1-1805-10-322
 10-Light Chandelier
 Warm Brass Finish
 60-1/2"W x 32"H
 Adj H 32" - 86"
 10C 60W
 Metal Candle Covers
 Clear Crystal

C. 1-1805-10-89
 10-Light Chandelier
 Matte Black Finish
 60-1/2"W x 32"H
 Adj H 32" - 86"
 10C 60W
 Metal Candle Covers
 Clear Crystal



Includes 12" & 6" extensions - additional stems available - 7-EXTLG



Dual Mount Hanging System

A. 1-1800-16-171
 16-Light Chandelier
 Burnished Brass Finish
 60"W x 15-1/2"H
 Adj H 15-1/2" - 69-1/2"
 16E 60W
 Clear Glass

B. 1-1800-16-89
 16-Light Chandelier
 Matte Black Finish
 60"W x 15-1/2"H
 Adj H 15-1/2" - 69-1/2"
 16E 60W
 Clear Glass

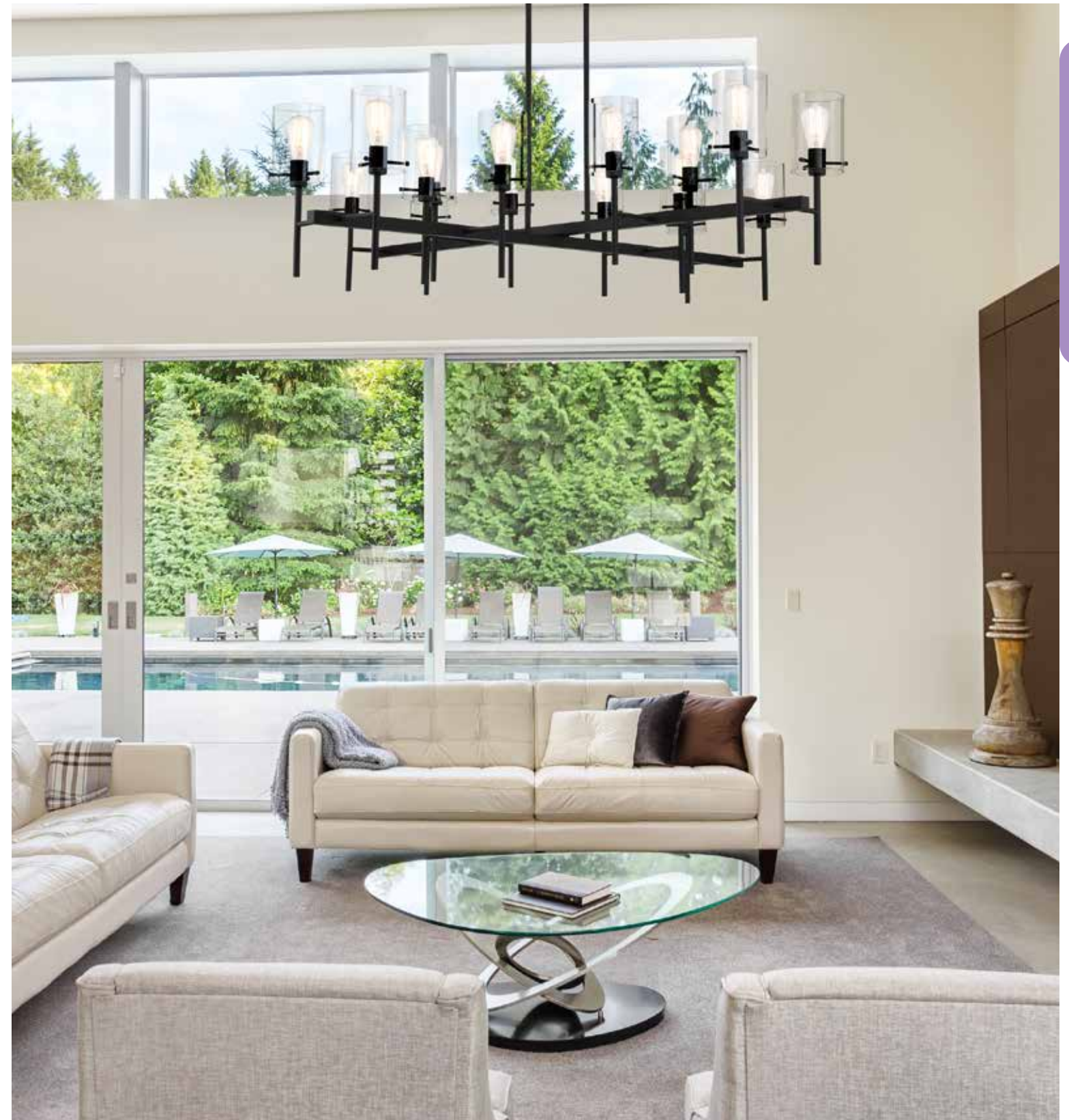

Includes 12" & 6" extensions - additional stems available - 7-EXTLG



1-1943-10-89
10-Light Chandelier
Matte Black Finish
45"W x 38"H
10E 60W
Clear Water Glass

Includes 120" chain & wire

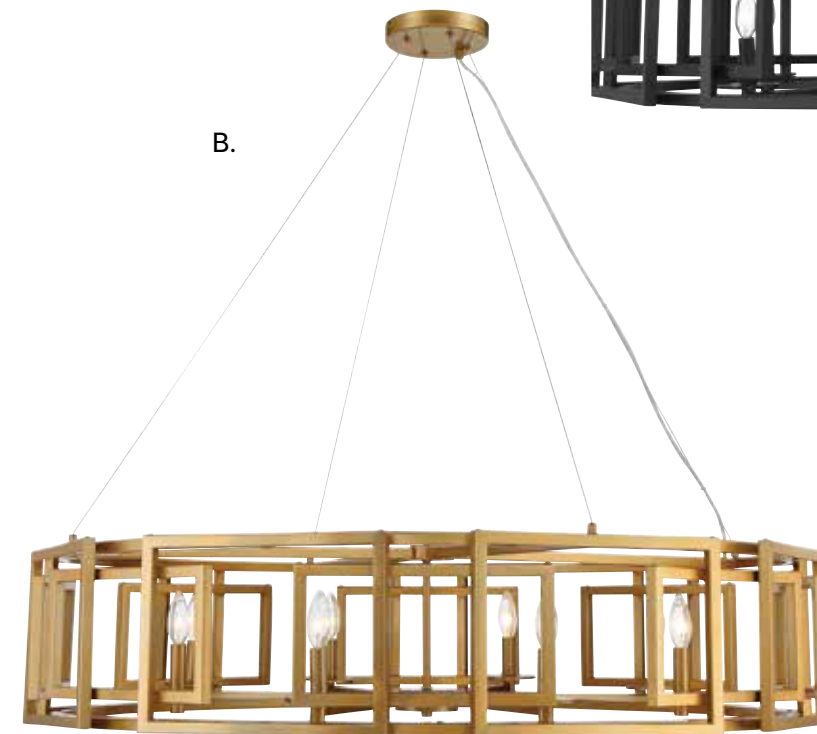
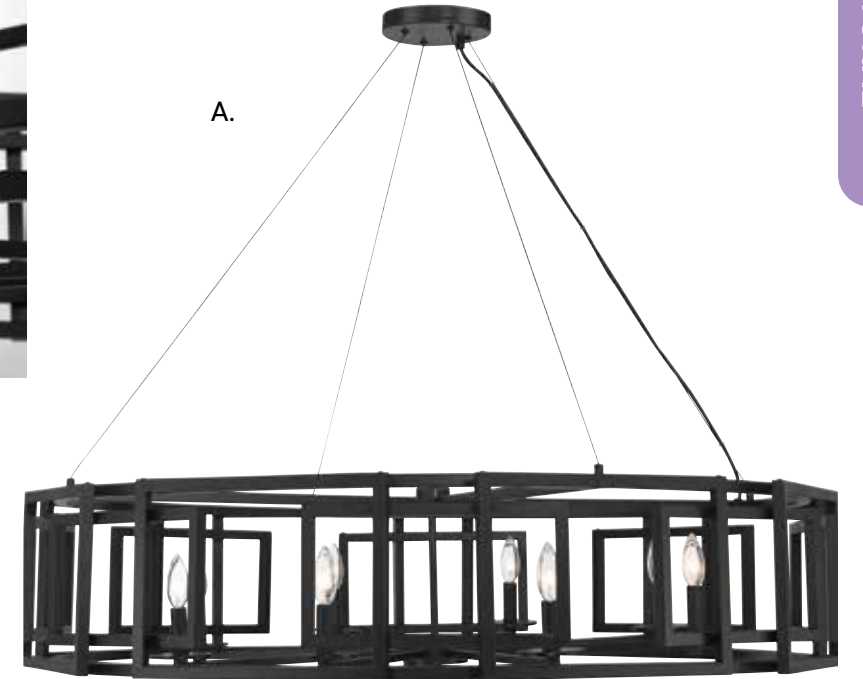

- A. 1-1675-8-89**
8-Light Chandelier
Matte Black Finish
45"W x 10"H
Adj H 10" - 130"
8C 60W
- B. 1-1675-8-171**
8-Light Chandelier
Burnished Brass Finish
45"W x 10"H
Adj H 10" - 130"
8C 60W

Includes 120" of cable



1-1938-36-89
 36-Light Chandelier
 Matte Black Finish
 60"W x 52"H
 36G9 4W
 Clear Crystal
G9 Bulbs Included

Includes 120" chain & wire



Sconce, Page 84, 272



Chandelier, Page 84



1-1934-12-143
12-Light Chandelier
Matte Black w/
Warm Brass Accents
45"W x 41"H
12E 60W
Clear Crystal

Includes 120" chain & wire



1-1932-15-322
15-Light Chandelier
Warm Brass Finish
45"W x 37"H
15C 60W
Clear Glass

Includes 120" chain & wire





- A. 1-1672-12-322**
12-Light Chandelier
Warm Brass Accents
50"W x 51"H
12C 60W
Natural Stone Candle Covers
- B. 1-1672-12-89**
12-Light Chandelier
Matte Black Finish
50"W x 51"H
12C 60W
Natural Stone Candle Covers



A.

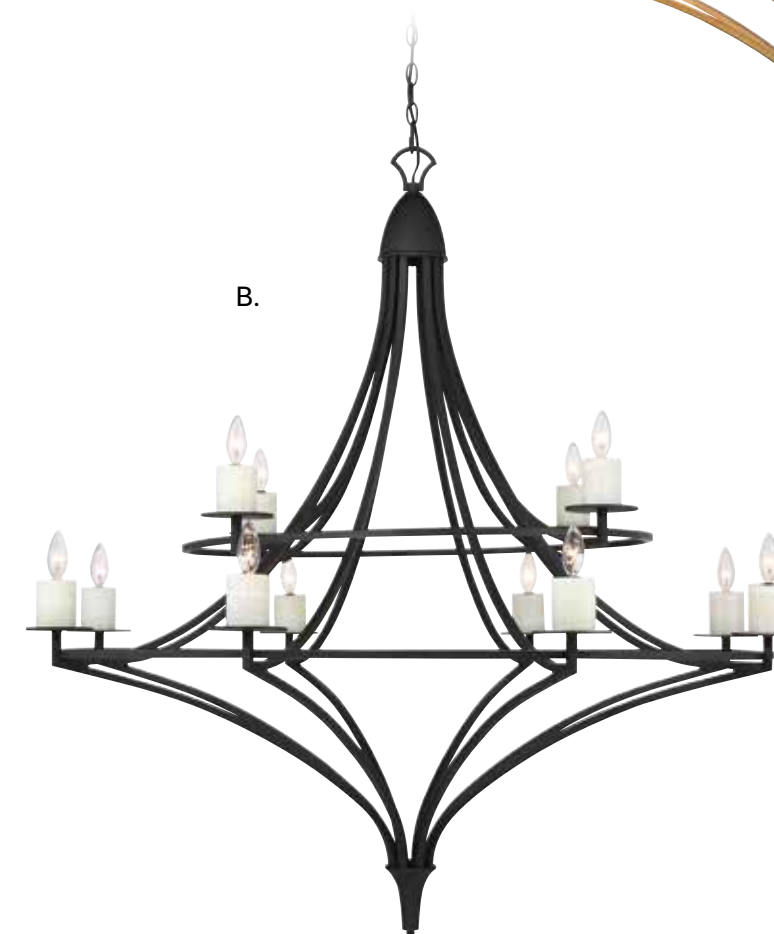

B.

Includes 120" chain & wire



1-9084-12-13
12-Light Chandelier
English Bronze Finish
48"W x 50-1/2"H
12C 60W
Metal Candle Covers

Includes 120" chain & wire



Includes 12" & 6" extensions - additional stems available - 7-EXTLG



A. 7-1690-1-143
1-Light Pendant
Matte Black w/
Warm Brass Accents
20"W x 8"H
Adj H 8" - 62"
1E 60W
White Opal Glass

B. 7-1690-1-175
1-Light Pendant
Gray w/ Polished
Nickel Accents
20"W x 8"H
Adj H 8" - 62"
1E 60W
White Opal Glass

C. 7-1690-1-142
1-Light Pendant
White w/
Warm Brass Accents
20"W x 8"H
Adj H 8" - 62"
1E 60W
White Opal Glass



Ceiling, Page 316

CARLYSLE

CARLYSLE

PENDANTS / LANTERNS

PENDANTS / LANTERNS



A. 6-4602-1-143
1-Light Flush Mount
Matte Black w/
Warm Brass Finish
15"W x 14-1/4"H
1E 60W
White Opal Glass

B. 6-4602-1-142
1-Light Flush Mount
White w/
Warm Brass Finish
15"W x 14-1/4"H
1E 60W
White Opal Glass

C. 7-4600-1-143
1-Light Pendant
Matte Black w/
Warm Brass Finish
15"W x 17"H
Adj H 17" - 71"
1E 60W
White Opal Glass

D. 7-4600-1-142
1-Light Pendant
White w/
Warm Brass Finish
15"W x 17"H
Adj H 17" - 71"
1E 60W
White Opal Glass



A.



B.



Dual Mount Hanging System



*C.



*D.

*Includes 12" & 6" extensions - additional stems available - 7-EXT

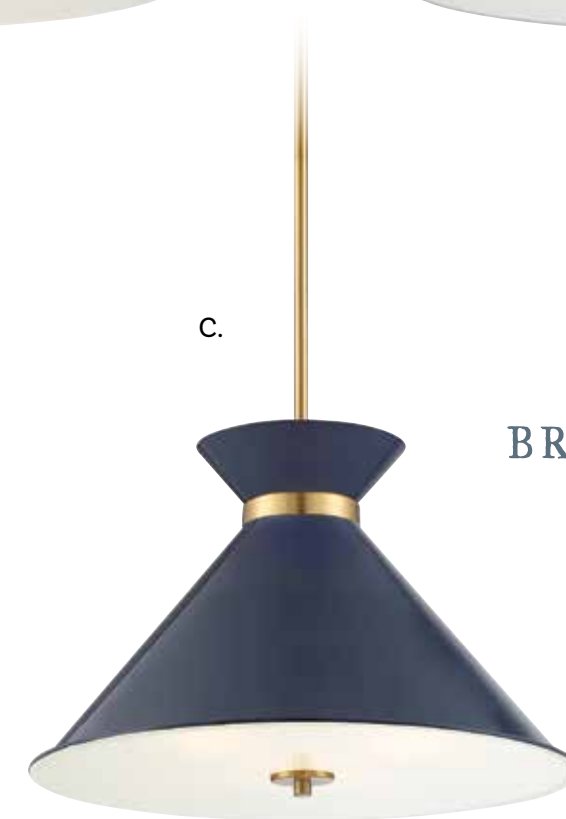

BRIAN THOMAS
COLLECTION

- A. 7-2416-3-143**
3-Light Pendant
Black w/ Warm Brass Finish
18"W x 11"H
Adj H 11"x 65"
3E 60W
30° Swivel
- B. 7-2416-3-160**
3-Light Pendant
White w/ Warm Brass Finish
18"W x 11"H
Adj H 11"x 65"
3E 60W
30° Swivel
- C. 7-2416-3-161**
3-Light Pendant
Navy Blue w/ Warm Brass Finish
18"W x 11"H
Adj H 11"x 65"
3E 60W
30° Swivel

Includes 12" & 6" extensions - additional stems available - 7-EXT



- A. 7-8882-1-172**
1-Light Pendant
White w/ Polished
Nickel Accents
16"W x 11"H
1E 60W
- B. 7-8882-1-174**
1-Light Pendant
Navy Blue w/ Polished
Nickel Accents
16"W x 11"H
1E 60W
- C. 7-8882-1-173**
1-Light Pendant
Black w/ Polished
Nickel Accents
16"W x 11"H
1E 60W
- D. 7-8882-1-175**
1-Light Pendant
Gray w/ Polished
Nickel Accents
16"W x 11"H
1E 60W



Sconce, Page 268

Includes (2) 10" decorative linked stems, plus 120" chain & wire



A.

B.

A. 7-5014-3-85
3-Light Pendant
Rubbed Zinc w/
Silver Leaf Finish
24"W x 15"H
3E 60W

B. 7-5014-3-84
3-Light Pendant
Rubbed Bronze w/
Gold Leaf Finish
24"W x 15"H
3E 60W

Includes 120" lamp cord



A.



B.



C.



D.

A. 7-885-1-182
1-Light Pendant
Chelsea Gold Finish
18"W x 13"H
1E 60W

B. 7-885-1-183
1-Light Pendant
Chelsea Walnut Finish
18"W x 13"H
1E 60W

C. 7-886-3-182
3-Light Pendant
Chelsea Gold Finish
23"W x 16"H
3E 60W

D. 7-886-3-183
3-Light Pendant
Chelsea Walnut Finish
23"W x 16"H
3E 60W



Pendant, Page 180



Includes 120" chain & wire



- A. 7-100-3-53**
3-Light Pendant
Silver Patina Finish
22-1/2"W x 11-1/2"H
3E 60W
- B. 7-101-6-53**
6-Light Pendant
Silver Patina Finish
30"W x 16"H
6E 60W
- C. 7-101-6-54**
6-Light Pendant
Gold Patina Finish
30"W x 16"H
6E 60W
- D. 7-100-3-54**
3-Light Pendant
Gold Patina Finish
22-1/2"W x 11-1/2"H
3E 60W

Includes 120" chain & wire

ROCHESTER

ROCHESTER

PENDANTS / LANTERNS



PENDANTS / LANTERNS

A.

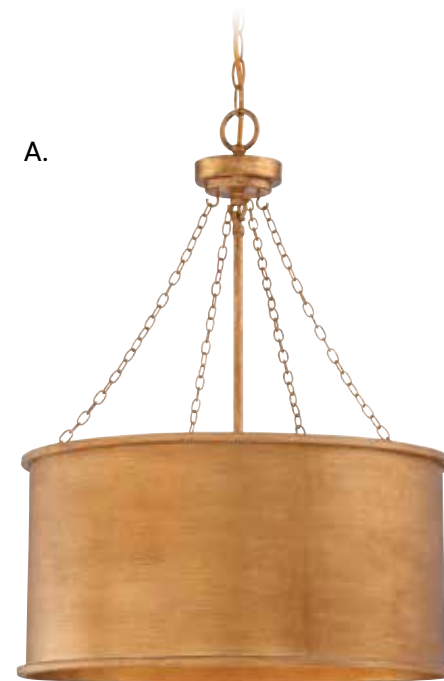

B.

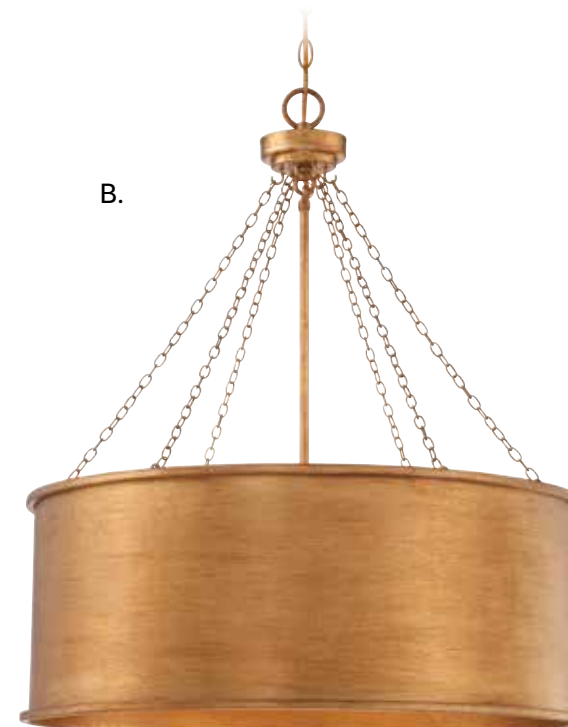

C.

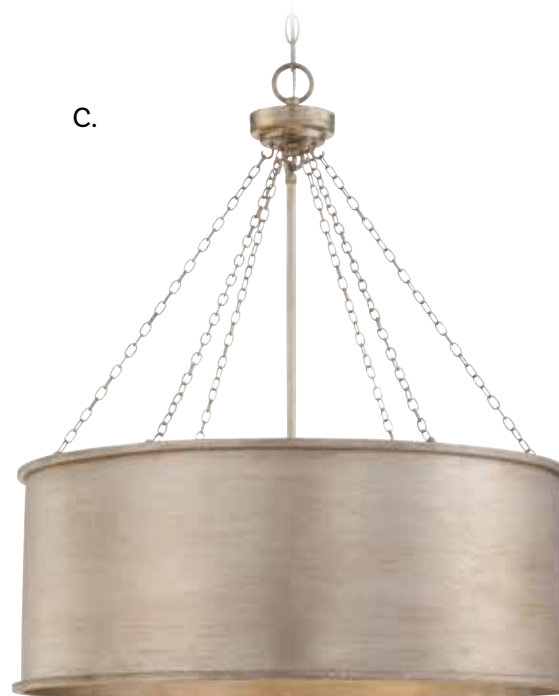

D.



A. 7-487-4-54
4-Light Pendant
Gold Patina Finish
19"W x 26-1/2"H
4E 60W

B. 7-488-6-54
6-Light Pendant
Gold Patina Finish
25"W x 29"H
6E 60W

C. 7-488-6-53
6-Light Pendant
Silver Patina Finish
25"W x 29"H
6E 60W

D. 7-487-4-53
4-Light Pendant
Silver Patina Finish
19"W x 26-1/2"H
4E 60W

Includes 120" chain & wire



A.

A. 7-8850-5-143
5-Light Pendant
Matte Black w/ Warm Brass Accents
20-1/2"W X 17"H
5C 60W



B.

B. 7-8850-5-142
5-Light Pendant
White w/ Warm Brass Accents
20-1/2"W X 17"H
5C 60W

Includes 120" chain & wire

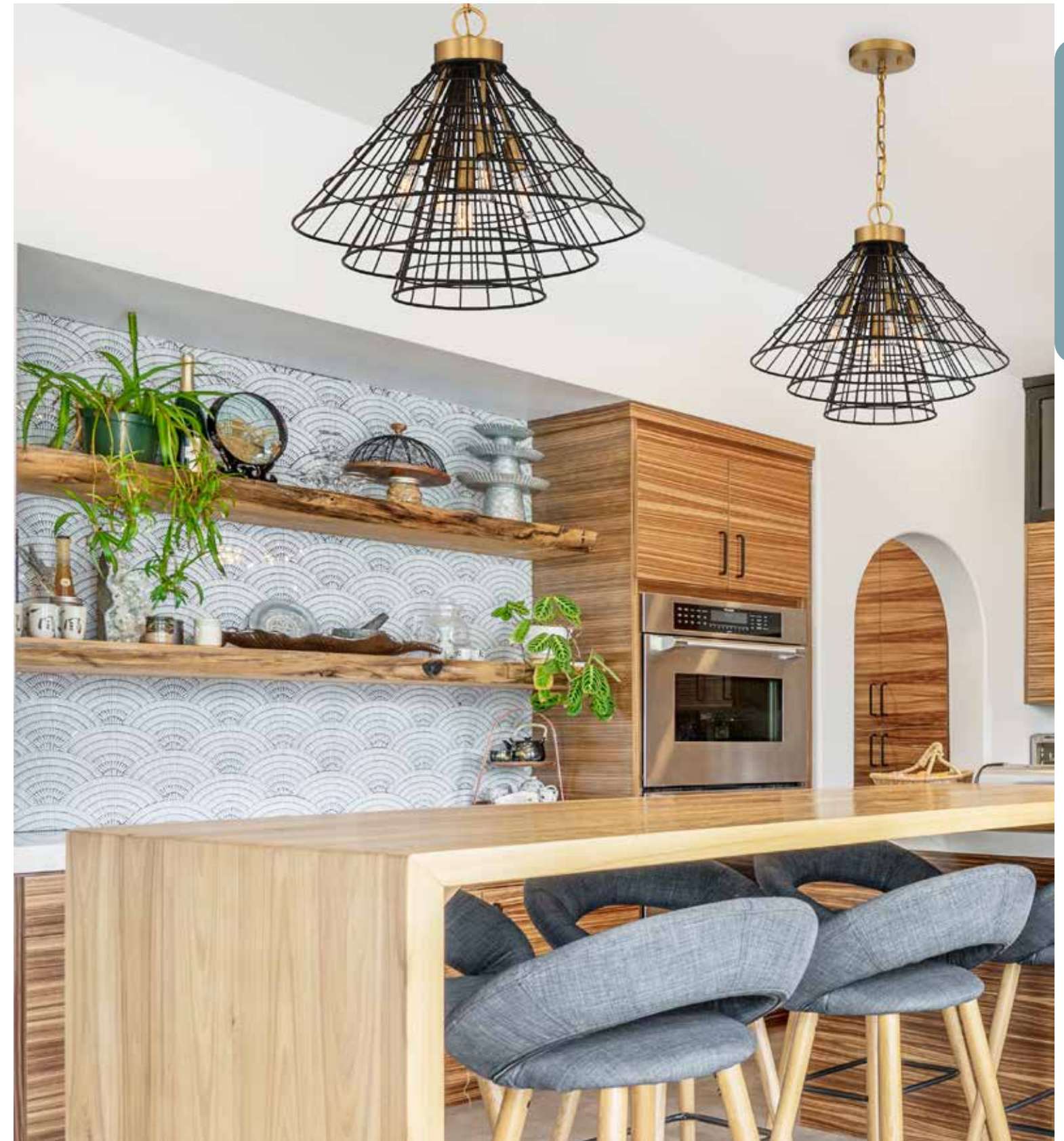

PENDANTS

PENDANTS

PENDANTS / LANTERNS

PENDANTS / LANTERNS



Dual Mount Hanging System

A. GIDEON
7-3168-3-322
 3-Light Pendant
 Warm Brass Finish
 16"W x 17-1/2"H
 Adj H 17-1/2" - 71-1/2"
 3C 60W
 Capiz Shell

B. ASTER
7-3398-1-322
 1-Light Pendant
 Warm Brass Finish
 16"W x 14-3/4"H
 Adj H 14-3/4" - 68-3/4"
 1E 60W
 White Vegan Leather

C. BENNINGTON
7-9703-2-322
 2-Light Pendant
 Warm Brass Finish
 8-3/4"W x 22"H
 Adj H 22" - 76"
 2C 60W
 Clear Ribbed Glass



*A.



**B.



**C.

*Includes 12" & 6" extensions - additional stems available - **7-EXTLG**

Includes 12" & 6" extensions - additional stems available - **7-EXT

TARTAN

PENDANTS / LANTERNS



Includes 120" chain & wire

SENECA

PENDANTS / LANTERNS

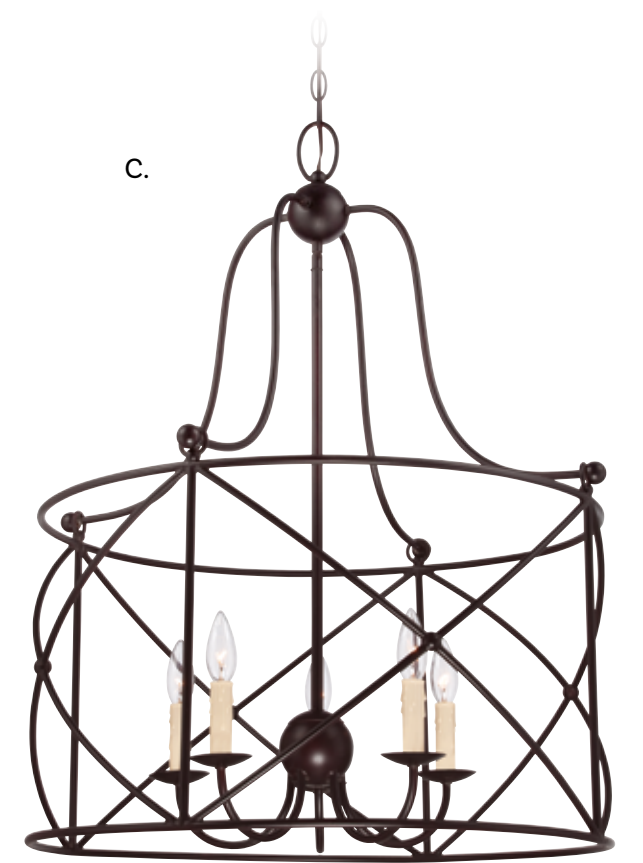

A. 7-9009-5-28
5-Light Pendant
Oiled Burnished Bronze Finish
28"W x 34"H
5E 60W
Mercury Glass

B. 7-9008-4-28
4-Light Pendant
Oiled Burnished Bronze Finish
20-3/8"W x 25-3/8"H
4E 60W
Mercury Glass

C. 1-4072-5-13
5-Light Pendant
English Bronze Finish
25-1/2"W x 32-3/8"H
5C 60W
Pale Cream Beeswax
Candle Covers

TALBOT

TALBOT/WINDSUNG

PENDANTS / LANTERNS



Includes 120" chain & wire

PENDANTS / LANTERNS



A. TALBOT
3-4081-4-79
4-Light Pendant
English Bronze w/ Warm Brass Finish
14"W x 28"H
4C 60W
Metal Candle Covers



B. TALBOT
3-4080-4-79
4-Light Pendant
English Bronze w/ Warm Brass Finish
10"W x 18"H
4C 60W
Metal Candle Covers



C. WINDSUNG
3-6821-4-13
4-Light Pendant
English Bronze
16"W x 33"H
4C 40W
Metal Candle Covers

PENDANTS

PENDANTS / LANTERNS



A. MACAULEY
7-2064-1-51
 1-Light Mini-Pendant
 Vintage Black w/
 Warm Brass Finish
 4-3/4"W x 13"H
 1E 60W
 Clear Glass

B. PULASKI
7-804-1-02
 1-Light Mini-Pendant
 Oiled Bronze Finish
 9-1/2"W x 25"H
 Adj H 25" - 53-1/2"
 1E 60W
 Clear Glass

*Includes 120" lamp cord

Includes 9-1/2" extensions - additional stems available - **7-EXT



*A.

**B.

PENDANTS

PENDANTS / LANTERNS



†c.

†d.



Dual Mount Hanging System

C. CHESTER
7-8891-3-194
 3-Light Pendant
 Mesquite Finish
 16"W x 21-1/2"H
 Adj H 21-1/2" - 75-1/2"
 3C 60W
 Clear Seeded Glass
 Metal Candle Covers

D. CHESTER
7-8890-1-194
 1-Light Pendant
 Mesquite Finish
 8-1/2"W x 16-1/2"H
 Adj H 16-1/2" - 45"
 1E 60W
 Clear Seeded Glass

†Includes 12" & 6" extensions - additional stems available - **7-EXT**

LINEAR LIGHTING

LINEAR LIGHTING



A. LUNA
1-1867-10-322
10-Light Linear Chandelier
Warm Brass Finish
36"L x 17"W x 20"H
10C 60W
Clear Crystal

B. LIVORNO
1-1847-8-127
8-Light Oval Chandelier
Noble Brass Finish
36"L x 15"W x 15"H
Adj H 15" - 69"
8C 60W
Clear Crystal



LINEAR LIGHTING

LINEAR LIGHTING

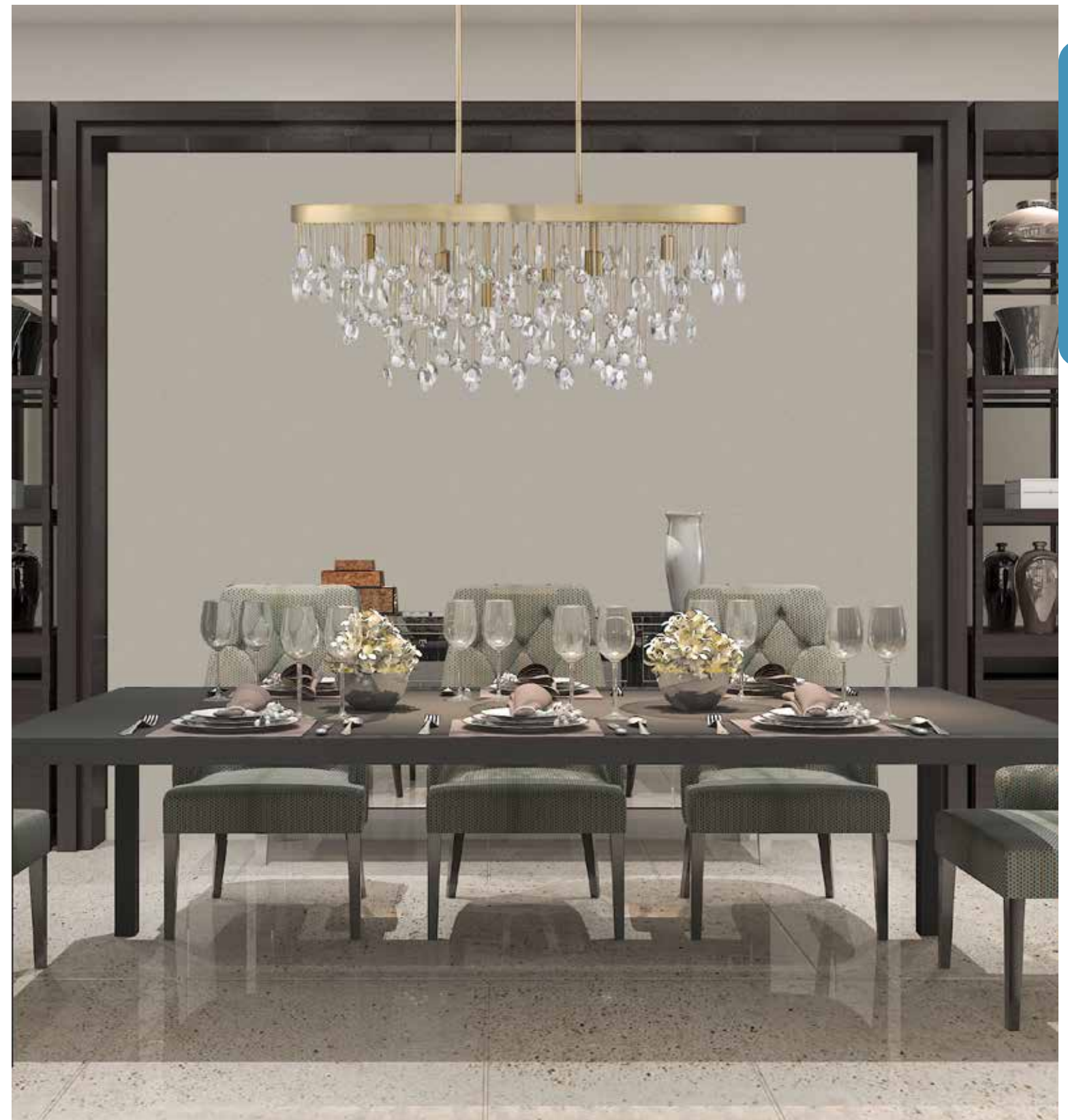

*Includes 120" chain & wire

**Includes 12" & 6" extensions - additional stems available - 7-EXT

LINEAR LIGHTING

LINEAR LIGHTING



*A.

A. TIVOLI
1-1889-8-143
 8-Light Linear Chandelier
 Matte Black w/
 Warm Brass Accents
 42"L x 16"W x 16"H
 Adj H 16" - 70"
 8C 60W
 White Fabric Shade



*B.

B. MIDLAND
1-1907-8-143
 8-Light Linear Chandelier
 Matte Black w/
 Warm Brass Accents
 40"L x 16"W x 14"H
 Adj H 14" - 68"
 8C 60W
 Clear Ribbed Glass

LINEAR LIGHTING

LINEAR LIGHTING



Dual Mount Hanging System

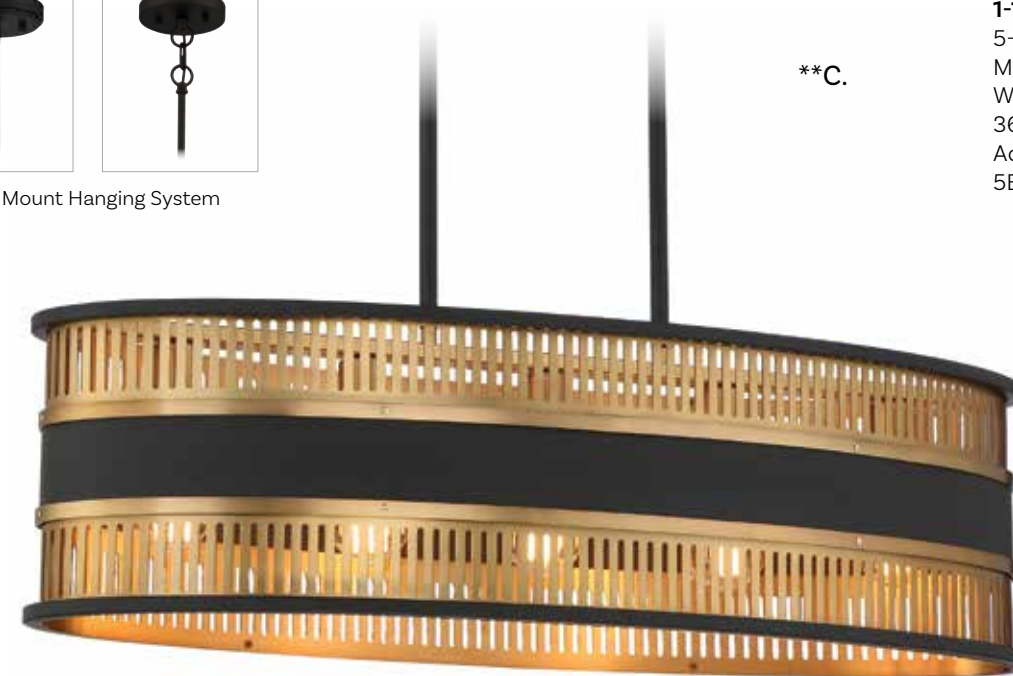

**C.

C. ECLIPSE
1-1813-5-143
 5-Light Linear Chandelier
 Matte Black w/
 Warm Brass Accents
 36"L x 14"W x 10"H
 Adj H 10" - 64"
 5E 60W

*Includes 12" & 6" extensions - additional stems available - 7-EXT

**Includes 12" & 6" extensions - additional stems available - 7-EXTLG

LINEAR LIGHTING

LINEAR LIGHTING



A. PORTIA
1-2032-6-260
 6-Light Linear Chandelier
 True Gold Finish
 42"L x 12"W x 11"H
 Adj H 11" - 65"
 6C 60W
 Clear Alabaster

A.



B. ASHOR
1-1636-8-143
 8-Light LED Linear Chandelier
 Matte Black w/
 Warm Brass Accents
 60"L x 18"W x 23"H
 Adj H 23" - 77"
 11W Integrated Dimmable LED
 2050 Lumens, 3000K, 90+ CRI
 Crushed Crystal

LED

B.

Includes 12" & 6" extensions - additional stems available - 7-EXT

LINEAR LIGHTING

LINEAR LIGHTING



C. HAVEN
1-1790-36-89
 LED Linear Chandelier
 Matte Black Finish
 38"L x 11-1/2"W x 11"H
 Adj H 11" - 65"
 36W Integrated Dimmable LED
 1817 Lumens, 3000K, 90+CRI

LED



Dual Mount Hanging System

C.



LINEAR LIGHTING

LINEAR LIGHTING



Dual Mount Hanging System

A. EDINA
1-191-6-143
 6-Light Oval Chandelier
 Matte Black w/
 Warm Brass Accents
 42"L x 17"W x 21"H
 Adj H 21" - 75"
 6E 60W
 Clear Crystal

A.

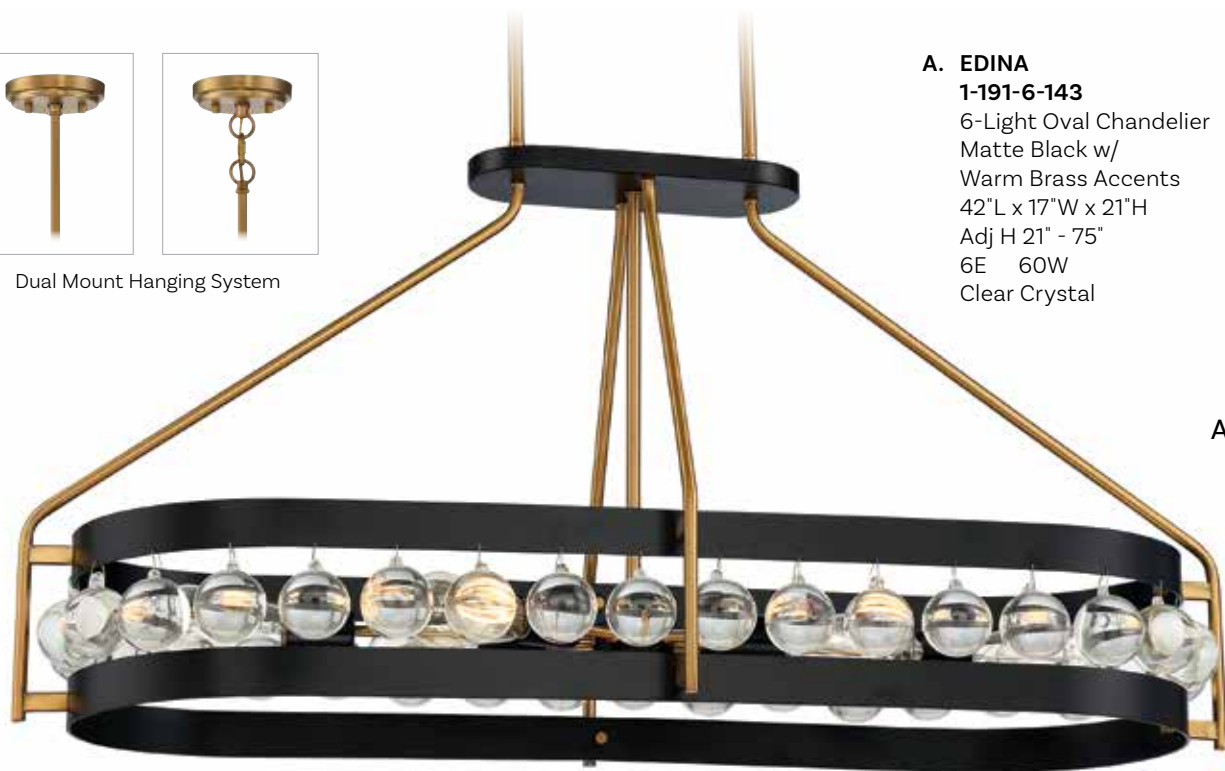

B. CAPELLA
1-5404-8-79
 8-Light Linear Chandelier
 English Bronze w/
 Warm Brass Finish
 42"L x 16"W x 12"H
 Adj H 12" - 66"
 8C 60W
 Clear Water Glass
 Metal Candle Covers

B.

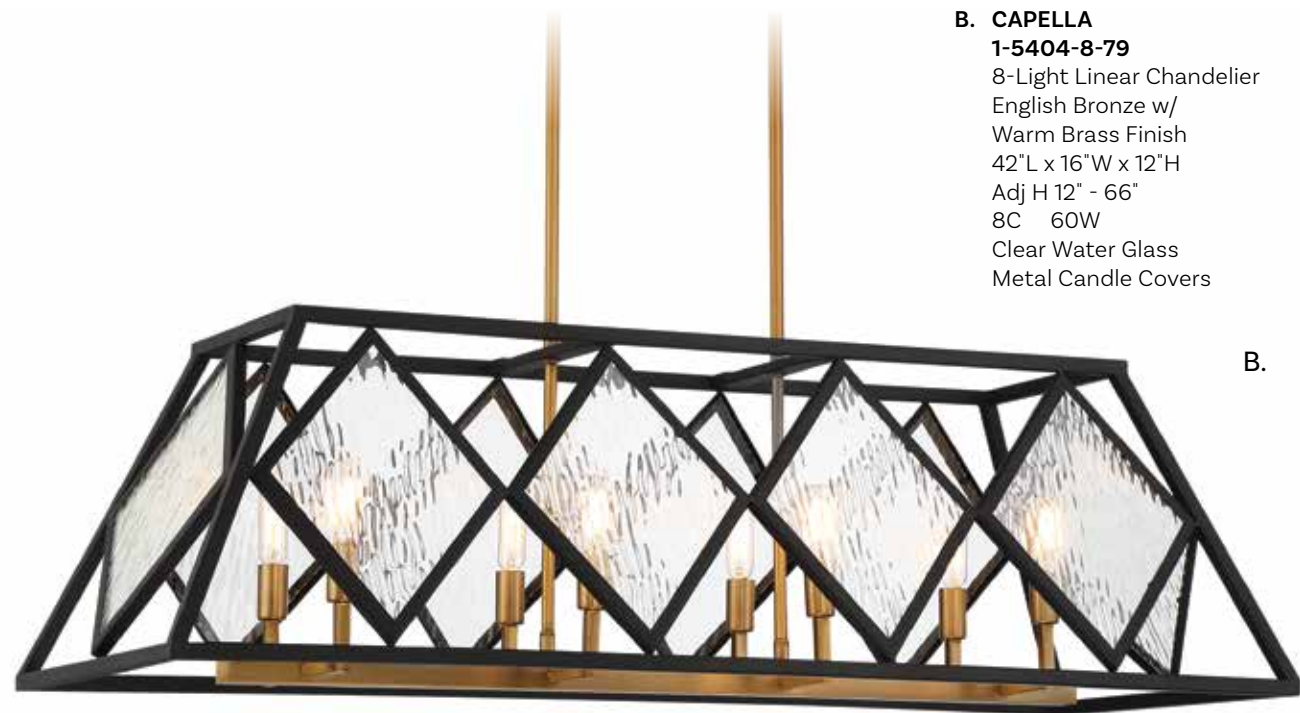

LINEAR LIGHTING

LINEAR LIGHTING



Dual Mount Hanging System

C. DELPHI
1-187-3-143
 3-Light Linear Chandelier
 Matte Black w/
 Warm Brass Accents
 42"L x 10"W x 11"H
 Adj H 11" - 65"
 3E 60W

C.



D. DELPHI
1-187-3-172
 3-Light Linear Chandelier
 White w/ Polished
 Nickel Accents
 42"L x 10"W x 11"H
 Adj H 11" - 65"
 3E 60W

D.



Includes 12" & 6" extensions - additional stems available - 7-EXT

LINEAR LIGHTING

LINEAR LIGHTING



Dual Mount Hanging System



A.

A. ARCHWAY
1-5533-8-143
8-Light Linear Chandelier
Warm Brass w/
Matte Black Finish
10"W x 12-1/2"H x 38"L
Adj H 12-1/2" - 66-1/2"
8C 60W

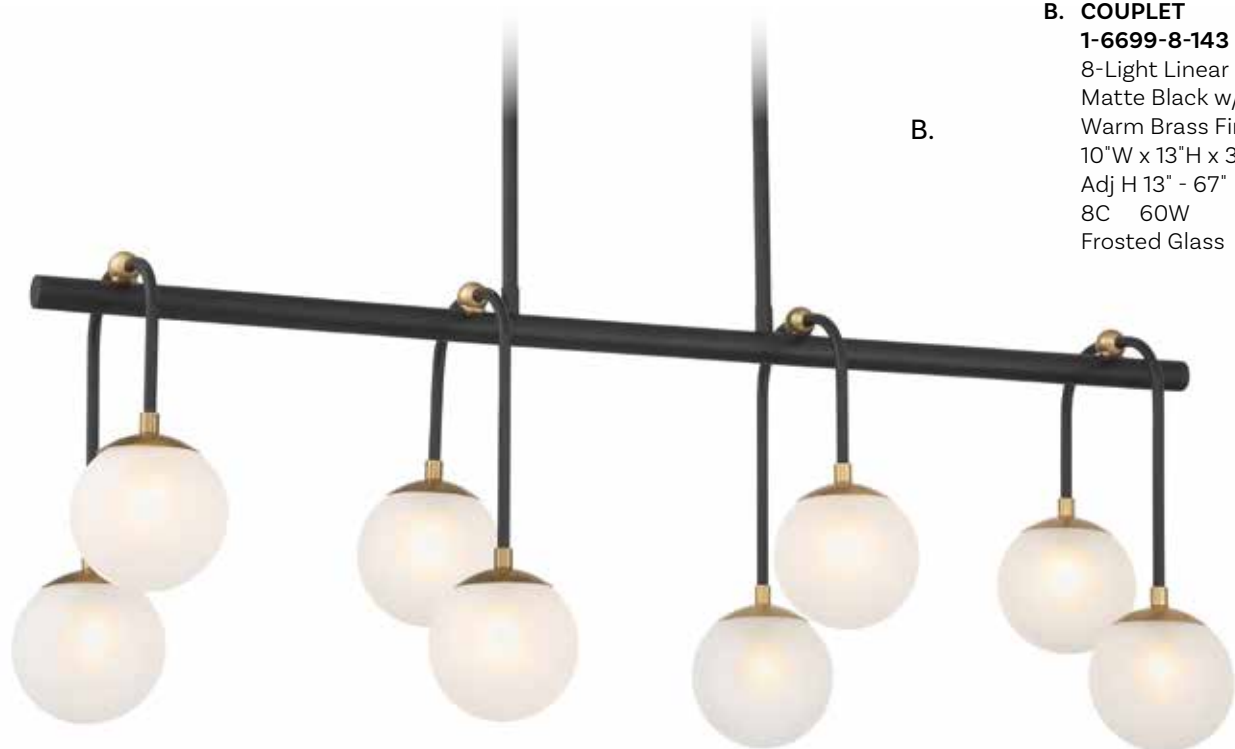

B.

B. COUPLET
1-6699-8-143
8-Light Linear Chandelier
Matte Black w/
Warm Brass Finish
10"W x 13"H x 38"L
Adj H 13" - 67"
8C 60W
Frosted Glass

LINEAR LIGHTING

LINEAR LIGHTING



Includes 12" & 6" extensions - additional stems available - 7-EXT

LINEAR LIGHTING

LINEAR LIGHTING



Includes 12" & 6" extensions - additional stems available - 7-EXT

LINEAR LIGHTING

LINEAR LIGHTING



Dual Mount Hanging System

A.

A. ASHE
1-1738-5-320
 5-Light Oval Chandelier
 Warm Brass & Rope
 42"L x 14"W x 9"H
 Adj H 9" - 63"
 5E 60W



B.

B. ASTORIA
1-1770-5-200
 5-Light Oval Chandelier
 Natural w/ Warm Brass
 44"L x 20"W x 10"H
 Adj H 10" - 64"
 5C 60W
 Cane Shade



LINEAR LIGHTING

LINEAR LIGHTING



Dual Mount Hanging System



*A.

A. QUATRIN
1-2305-8-260
 8-Light Linear Chandelier
 True Gold Finish
 15-1/2"W x 21"H x 41-1/4" L
 Adj H 21" - 75"
 8E 60W
 White Opal Glass

*B.

B. GIDEON
1-3165-8-322
 8-Light Linear Chandelier
 Warm Brass Finish
 14-1/2"W x 5-1/4"H x 47-3/4" L
 Adj H 5-1/4" - 59-1/4"
 8C 60W
 Capiz Shell

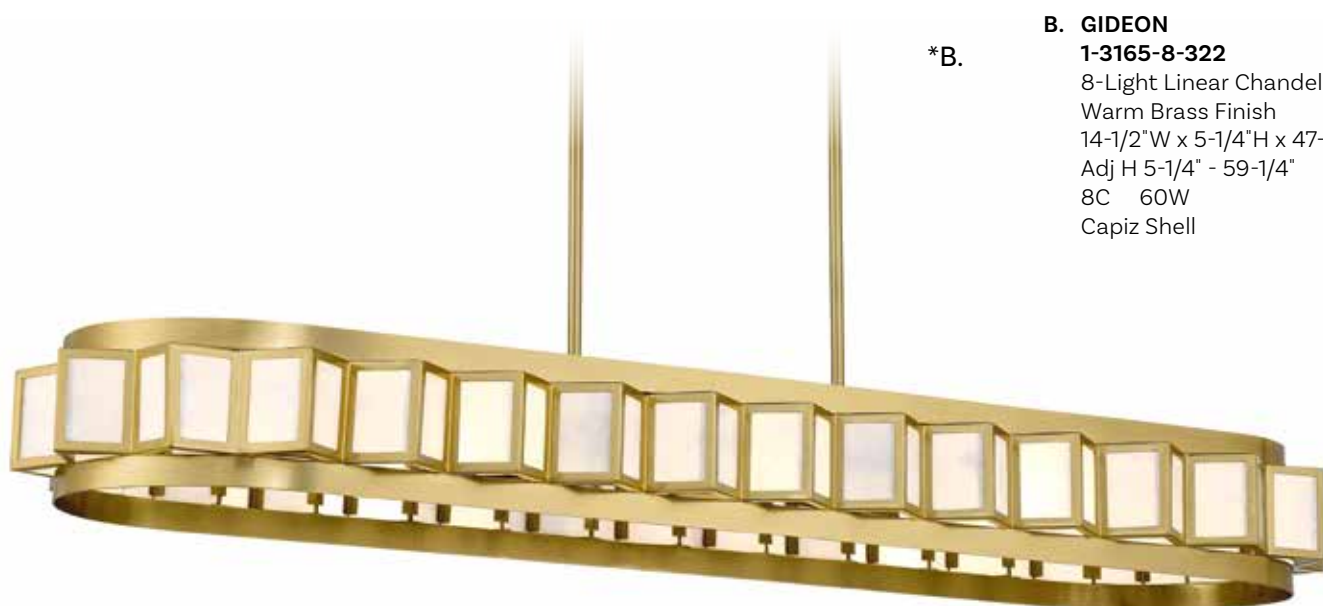

LINEAR LIGHTING

LINEAR LIGHTING



*C.

C. HASTING
1-8892-5-101
 5-Light Linear Chandelier
 Noblewood w/ Iron Finish
 10"W x 12"H x 42"L
 Adj H 12" - 66"
 5E 60W

**D.

D. BISCAYNE
1-4488-8-89
 8-Light Linear Chandelier
 Matte Black Finish
 6-1/4"W x 6-1/2"H x 40" L
 Adj H 6-1/2" - 126-1/2"
 4.5W Integrated
 Dimmable LED
 300 Lumens per bulb,
 3000K, 90+ CRI
 Bubble Glass

LED

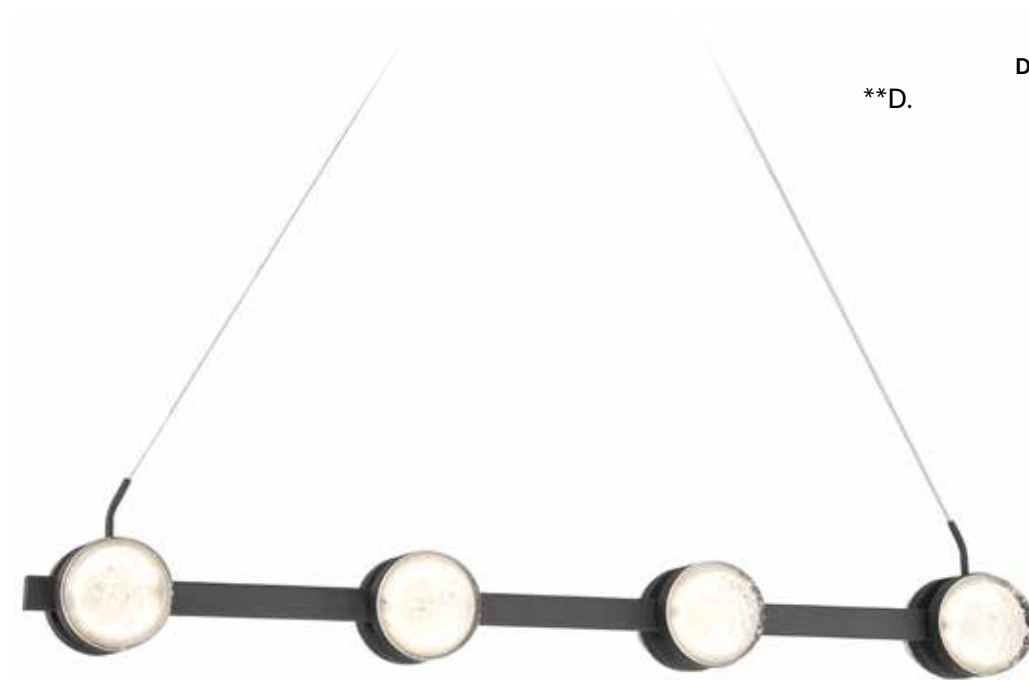

*Includes 12" & 6" extensions - additional stems available - 7-EXT
 **Includes 120" lamp cord

LINEAR LIGHTING



A. BURGESS
1-990-8-41
8-Light Linear Chandelier
Durango Finish
42"L x 5"W x 38-1/4"H
8E 60W

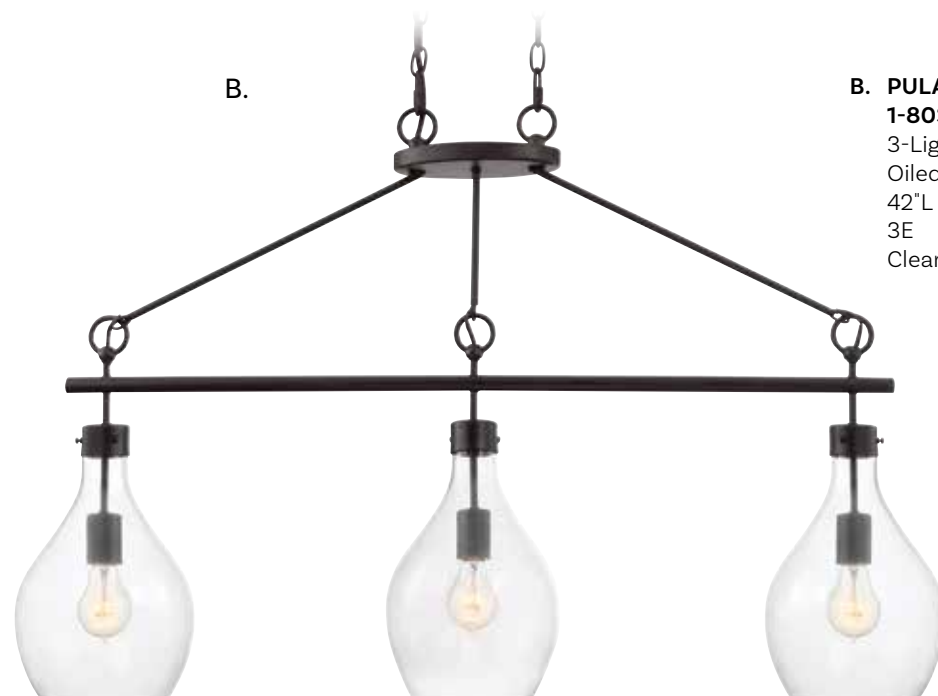

B. PULASKI
1-803-3-02
3-Light Linear Chandelier
Oiled Bronze Finish
42"L x 7-3/4"W x 26-1/4"H
3E 60W
Clear Glass

Includes 120" chain & wire

LINEAR LIGHTING

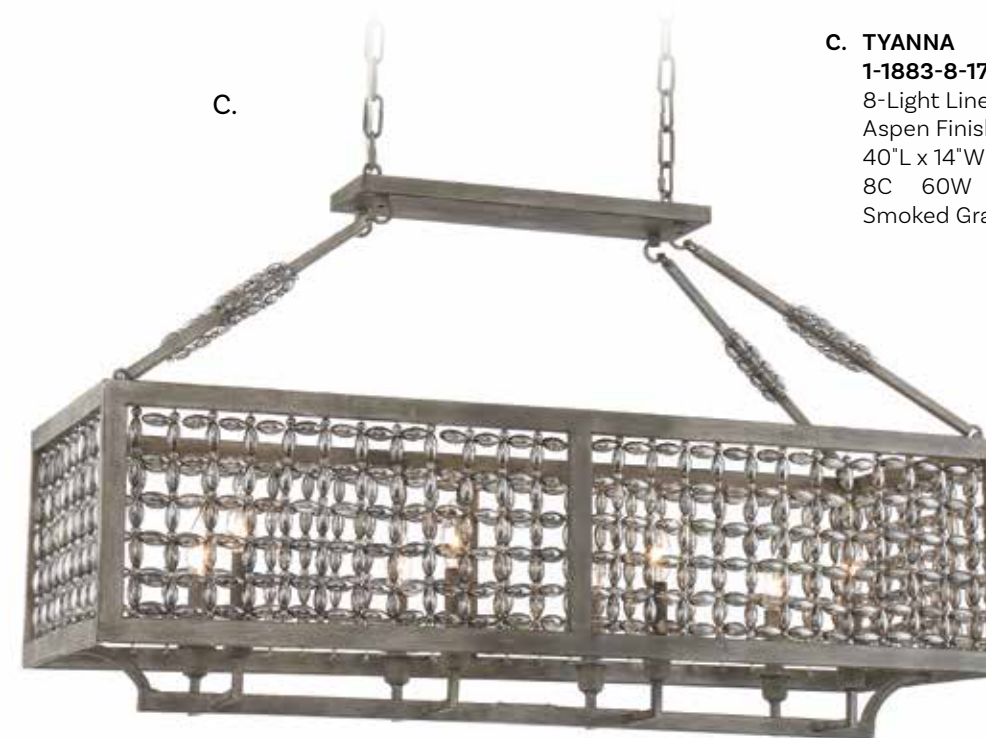

C. TYANNA
1-1883-8-178
8-Light Linear Chandelier
Aspen Finish
40"L x 14"W x 24"H
8C 60W
Smoked Gray Crystal

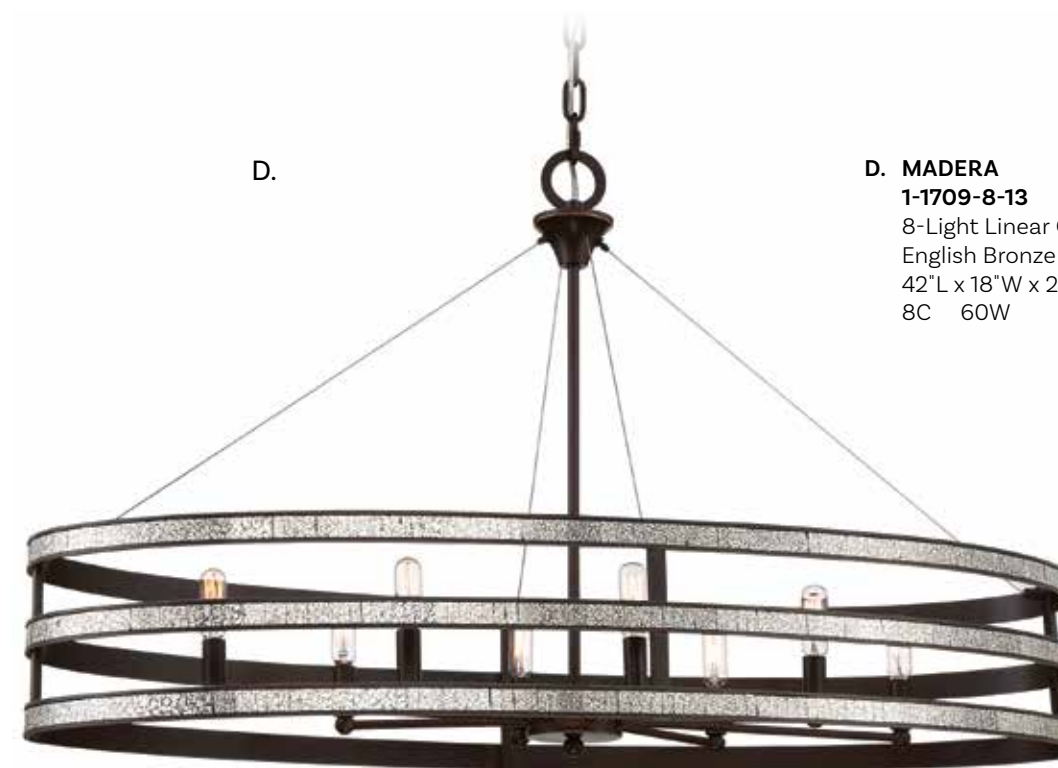

D. MADERA
1-1709-8-13
8-Light Linear Chandelier
English Bronze Finish
42"L x 18"W x 24"H
8C 60W

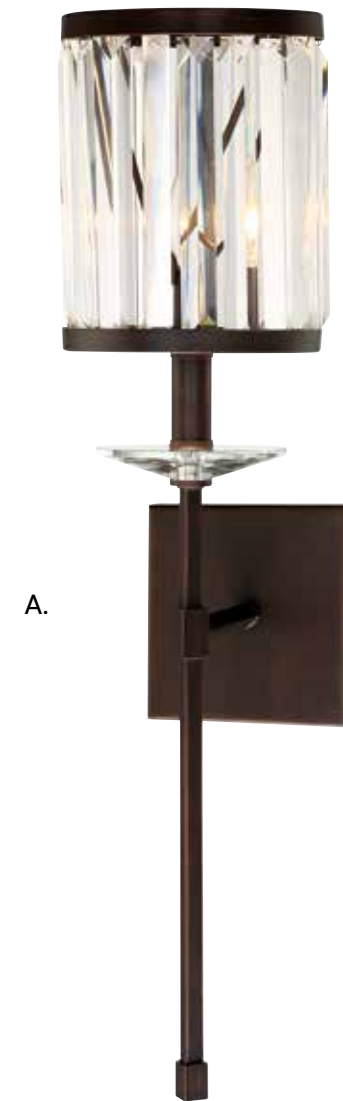

A.

A. 9-400-1-121
 1-Light Sconce
 Mohican Bronze Finish
 6-1/2" W x 26"H x 8"E
 1C 60W
 Clear Crystal



B.

B. 9-400-1-11
 1-Light Sconce
 Polished Chrome Finish
 6-1/2" W x 26"H x 8"E
 1C 60W
 Clear Crystal

ALVARA

WALL LIGHTING



A. ALVARA
9-1645-1-143
 1-Light Sconce
 Matte Black w/
 Warm Brass Accents
 5-1/2"W x 22-1/2"H x 7-1/2"E
 1E 60W
 White Opal Glass

B. ALVARA
9-1645-1-173
 1-Light Sconce
 Matte Black w/
 Polished Nickel Accents
 5-1/2"W x 22-1/2"H x 7-1/2"E
 1E 60W
 White Opal Glass



A.



B.

ALBERTA

WALL LIGHTING



C. ALBERTA
9-1902-1-322
 1-Light Sconce
 Warm Brass Finish
 4-1/2"W x 17-1/2"H x 4"E
 1E 60W
 Piastra Glass
300MM T9 Bulb Included

D. ALBERTA
9-1902-1-13
 1-Light Sconce
 English Bronze Finish
 4-1/2"W x 17-1/2"H x 4"E
 1E 60W
 Piastra Glass
300MM T9 Bulb Included



C.



D.

WALL LIGHTING

WALL LIGHTING

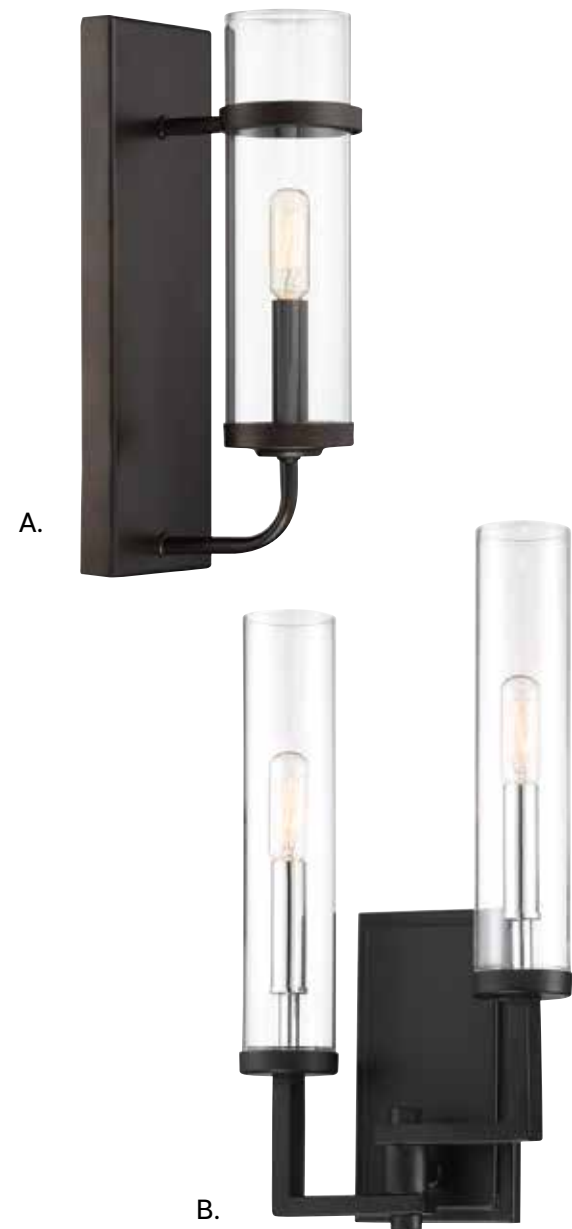

A. TULSA
9-6054-1-13
 1-Light Sconce
 English Bronze Finish
 4-3/4"W x 13-3/4"H x
 6-1/4"E
 1C 60W
 Clear Glass
 Metal Candle Cover

B. FOLSOM
9-2134-2-67
 2-Light Adjustable Sconce
 Matte Black w/ Polished
 Chrome Accents
 8"W x 17"H x 3-1/2"E
 Adj E 3-1/2" - 6-3/4"
 2C 60W
 Clear Glass
 Metal Candle Cover



C. 9-100-1-109
 1-Light Sconce
 Polished Nickel Finish
 4-1/2"W x 14"H x 4-1/2"E
 1E 60W
 Clear Glass

D. 9-100-1-44
 1-Light Sconce
 Classic Bronze Finish
 4-1/2"W x 14"H x 4-1/2"E
 1E 60W
 Clear Glass

WALL LIGHTING



Includes cord, plug, and hardwire hardware

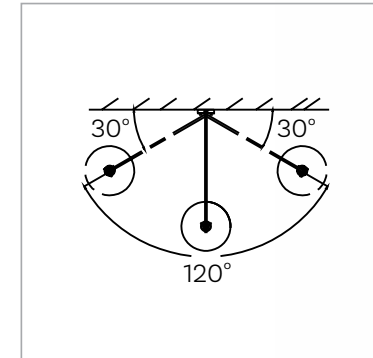

A. 9-195CP-1-89
1-Light Adjustable Sconce
Matte Black Finish
14-1/2"W x 22"H x 38"E
1E 60W
Metal Shade



B. 9-195CP-1-322
1-Light Adjustable Sconce
Warm Brass Finish
14-1/2"W x 22"H x 38"E
1E 60W
Metal Shade



A. 9-1665CP-1-89
 1-Light Adjustable Sconce
 Matte Black Finish
 36"W x 13"H x 13-1/2"E
 1E 60W
 White Fabric Shade

B. 9-1665CP-1-322
 1-Light Adjustable Sconce
 Warm Brass Finish
 36"W x 13"H x 13-1/2"E
 1E 60W
 Black Fabric Shade

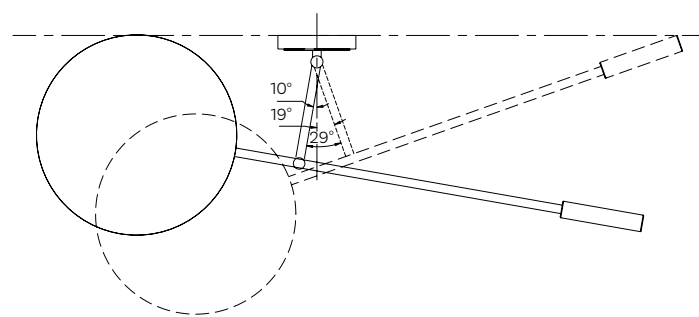

GAVIN

CORNING

WALL LIGHTING



A.



B.



C.



A. 9-1686-1-142
1-Light Sconce
White w/
Warm Brass Accents
9"W x 8"H x 10"E
1G9 3.5W
G9 Bulbs Included

B. 9-1686-1-143
1-Light Sconce
Matte Black w/
Warm Brass Accents
9"W x 8"H x 10"E
1G9 3.5W
G9 Bulbs Included

C. 9-1686-1-175
1-Light Sconce
Gray w/
Polished Nickel Accents
9"W x 8"H x 10"E
1G9 3.5W
G9 Bulbs Included



D.



E.



F.



G.

D. 9-8884-1-172
1-Light Sconce
White w/ Polished
Nickel Accents
8"W x 10-1/2"H x 9-1/2" E
1E 60W

E. 9-8884-1-173
1-Light Sconce
Matte Black w/ Polished
Nickel Accents
8"W x 10-1/2"H x 9-1/2" E
1E 60W

F. 9-8884-1-174
1-Light Sconce
Navy Blue w/ Polished
Nickel Accents
8"W x 10-1/2"H x 9-1/2" E
1E 60W

G. 9-8884-1-175
1-Light Sconce
Gray w/ Polished
Nickel Accents
8"W x 10-1/2"H x 9-1/2" E
1E 60W

WALL LIGHTING



Pendant, Page 222

WALL LIGHTING

WALL LIGHTING



WALL LIGHTING

WALL LIGHTING



A.



C.



D.



B.

- A. GIDEON**
9-3164-2-322
 2-Light Sconce
 Warm Brass Finish
 10"W x 11"H x 4-1/2"E
 2C 60W
 Capiz Shell

- B. COUPLET**
9-6696-2-143
 2-Light Sconce
 Matte Black w/
 Warm Brass Finish
 10-3/4"W x 20"H x 4-3/4"E
 2G9 60W
 Frosted Glass
G9 Bulbs Included

- C. KAHN**
9-6624-1-89
 1-Light Sconce
 Matte Black Finish
 5"W x 9"H x 4"E
 4.5W Integrated
 Dimmable LED
 300 Lumens
 3000K, 90+ CRI
 Clear Water Glass

- D. BISCAYNE**
9-4484-2-89
 2-Light Sconce
 Matte Black Finish
 4-1/2"W x 5-1/2"H x 5-3/4"E
 4.5W Integrated
 Dimmable LED
 496 Lumens per bulb,
 3000K, 90+ CRI
 Bubble Glass

WALL LIGHTING

A. BEACON
9-183-2-171
 2-Light Sconce
 Burnished Brass Finish
 8"W x 16"H x 4"E
 2C 60W
 Frosted White Glass

A.



B. PORTIA
9-2030-2-260
 2-Light Sconce
 True Gold Finish
 8" W x 16"H x 4-3/4"E
 2C 60W
 Strie Piastra Glass

B.



C. QUATRIN
9-2302-1-260
 1-Light Sconce
 True Gold Finish
 4-3/4"W x 16-1/4"H x 6-1/4"E
 1E 60W
 White Opal Glass

C.



D. DAHLIA
9-4364-1-322
 1-Light Sconce
 Warm Brass Finish
 9"W x 9-1/4"H x 5" E
 1C 60W
 White Fabric Shade
 Clear Crystal

D.



E. BENNINGTON
9-9702-2-322
 2-Light Sconce
 Warm Brass Finish
 6-1/4"W x 15"H x 6-1/2" E
 2C 60W
 Clear Ribbed Glass

E.



F. SULLIVAN
9-2204-2-322
 2-Light Sconce
 Warm Brass Finish
 10"W x 9"H x 10" E
 2C 60W

F.



G.



H.



G. ARCHWAY
9-5531-2-143
 2-Light Sconce
 Warm Brass w/
 Matte Black Finish
 9"W x 12-1/2"H x 4"E
 2C 60W

H. QUINCY
9-9944-1-143
 1-Light Sconce
 Warm Brass w/
 Matte Black Finish
 5-1/4"W x 18-1/2"H x 7"E
 1C 60W
 Metal Shade

I.



J.



I. SHELLBOURNE
9-2104-1-322
 1-Light Sconce
 Warm Brass Finish
 5"W x 16-1/2"H x 6-1/2"E
 1C 60W
 Handmade Piastra Glass

J. HAVEN
9-1792-15-89
 LED Sconce
 Matte Black Finish
 8-1/2"W x 16"H x 4"E
 15.5W Dimmable LED
 520 Lumens, 3000K, 90+ CRI
 Clear Crystal

K.



L.



K. ROSENDAL
9-256-1-307
 1-Light Sconce
 Silver Sparkle Finish
 7-1/2"W x 17-1/4"H x 8-1/2"E
 1C 60W
 Champagne Fabric Shade
 K9 Crystal Accents

L. DRYDEN
9-1940-2-89
 2-Light Sconce
 Matte Black Finish
 4-1/2"W x 12"H x 5-1/2"E
 2G9 4W
 Clear Crystal
G9 Bulbs Included

WALL LIGHTING

WALL LIGHTING



A.



B.



C.



D.



E.



F.



G.



H.



I.



J.



K.



L.

- | | | | | | | | | | | | |
|---|--|--|--|---|---|--|---|---|---|--|---|
| <p>A. MACAULEY
9-2065-1-51
1-Light Sconce
Vintage Black w/
Warm Brass
Accents
4-3/4"W x 20"
x 7"E
1E 60W
Clear Glass</p> | <p>B. DUNBAR
9-9065-1-95
1-Light Sconce
Warm Brass w/
Bronze Accents
4-3/4"W x 16"
x 6-3/4"E
1C 60W
Clear Glass</p> | <p>C. FULTON
9-5005-1-79
1-Light Sconce
English Bronze &
Warm Brass
Finish
5-1/2"W x 24-1/2"
x 7"E
1C 60W
Clear Glass</p> | <p>D. KIRSCH
9-1924-1-261
1-Light Sconce
Matte Black w/
True Gold Accents
6"W x 13"H
x 5-1/2"E
1C 60W</p> | <p>E. HAYWARD
9-1697-1-143
1-Light Sconce
Matte Black w/
Warm Brass
Accents
6"W x 12"H x 4-1/4"
E
1E 60W
Strie Piastra Glass</p> | <p>F. EATON
9-1977-1-143
1-Light Sconce
Matte Black w/
Warm Brass
Accents
6"W x 8-1/4"H x 7"
E
1E 60W
Clear Outer Glass
White Opal
Chimney</p> | <p>G. ABEL
9-1638-1-143
1-Light Sconce
Matte Black w/
Warm Brass
Accents
5"W x 19-1/2"
H
x 4"E
8W Integrated
Dimmable LED
300 Lumens,
3000K, 90+ CRI
White Opal Glass</p> | <p>H. KEARNEY
9-8073-2-51
2-Light Sconce
Vintage Black w/
Warm Brass
Accents
12"W x 15"H x 6"
E
2C 60W
Clear Glass
Metal Candle
Covers</p> | <p>I. TIVOLI
9-1888-1-143
1-Light Sconce
Matte Black w/
Warm Brass
Accents
5"W x 19"H x 6"
E
1C 60W
White Fabric
Shade
Clear Crystal
Accents</p> | <p>J. CLAYTON
9-2262-1-79
1-Light Sconce
English Bronze w/
Warm Brass
Finish
5"W x 11"H x
6-1/2"E
1E 60W
Clear Glass</p> | <p>K. OBERYN
9-9157-1-51
1-Light Sconce
Vintage Black w/
Warm Brass
Accents
5-1/2"W x 21-1/2"
H
x 5-1/2"E
1C 60W
Clear Seeded
Glass</p> | <p>L. MIDLAND
9-1905-2-143
2-Light Sconce
Matte Black w/
Warm Brass
Accents
10-1/2"W x 20"
H
x 5"E
2C 60W
Clear Ribbed Glass</p> |
|---|--|--|--|---|---|--|---|---|---|--|---|

WALL LIGHTING

WALL LIGHTING

WALL LIGHTING



- A. LORAINNE**
9-9004-1-88
 1-Light Sconce
 Oxidized Black Finish
 4-3/4"W x 17-1/2"H x 5"E
 1C 60W
 Soft White Fabric Shade
 Metal Candle Cover
- B. LORAINNE**
9-9004-2-88
 2-Light Sconce
 Oxidized Black Finish
 12-1/2"W x 17-1/2"H x 6"E
 2C 60W
 Soft White Fabric Shade
 Metal Candle Covers
- C. SOUTHERBY**
9-0159-2-76
 2-Light Sconce
 Florencian Bronze Finish
 13-1/2"W x 19"H x 6"E
 2C 60W
 Cream Beeswax Candle Covers



- D. OBERON**
9-5950-2-25
 2-Light Sconce
 Slate Finish
 11"W x 25"H x 4"E
 2C 60W
 Soft White Linen Shade
 Metal Candle Covers

WALL LIGHTING

WALL LIGHTING

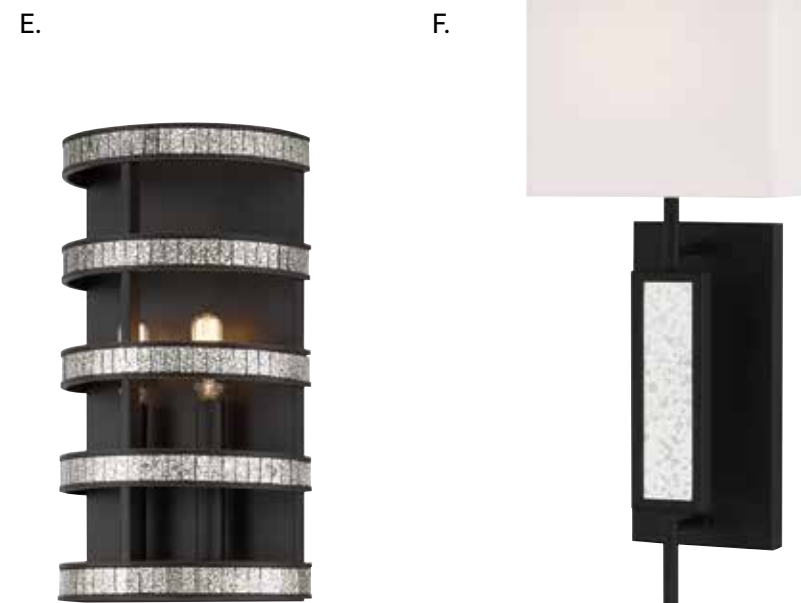

- E. MADERA**
9-1710-2-13
 2-Light Sconce
 English Bronze Finish
 8"W x 14"H x 4-1/2"E
 2C 60W
- F. VICTOR**
9-1750-1-89
 1-Light Sconce
 Matte Black Finish
 8"W x 23"H x 5"E
 1C 60W
 White Fabric Shade
 Antique Mirror Accent



- G. JAYLAR**
9-1648-1-89
 1-Light Sconce
 Matte Black Finish
 5"W x 9"H x 7"E
 1E 60W
 Natural Cane Shade
- H. JAYLAR**
9-1649-1-89
 1-Light Sconce
 Matte Black Finish
 5"W x 20"H x 6"E
 1C 60W
 Natural Cane Shade

BENNINGTON

POUR LE BAIN



Fixtures may be mounted either uplight or downlight

BENNINGTON

POUR LE BAIN

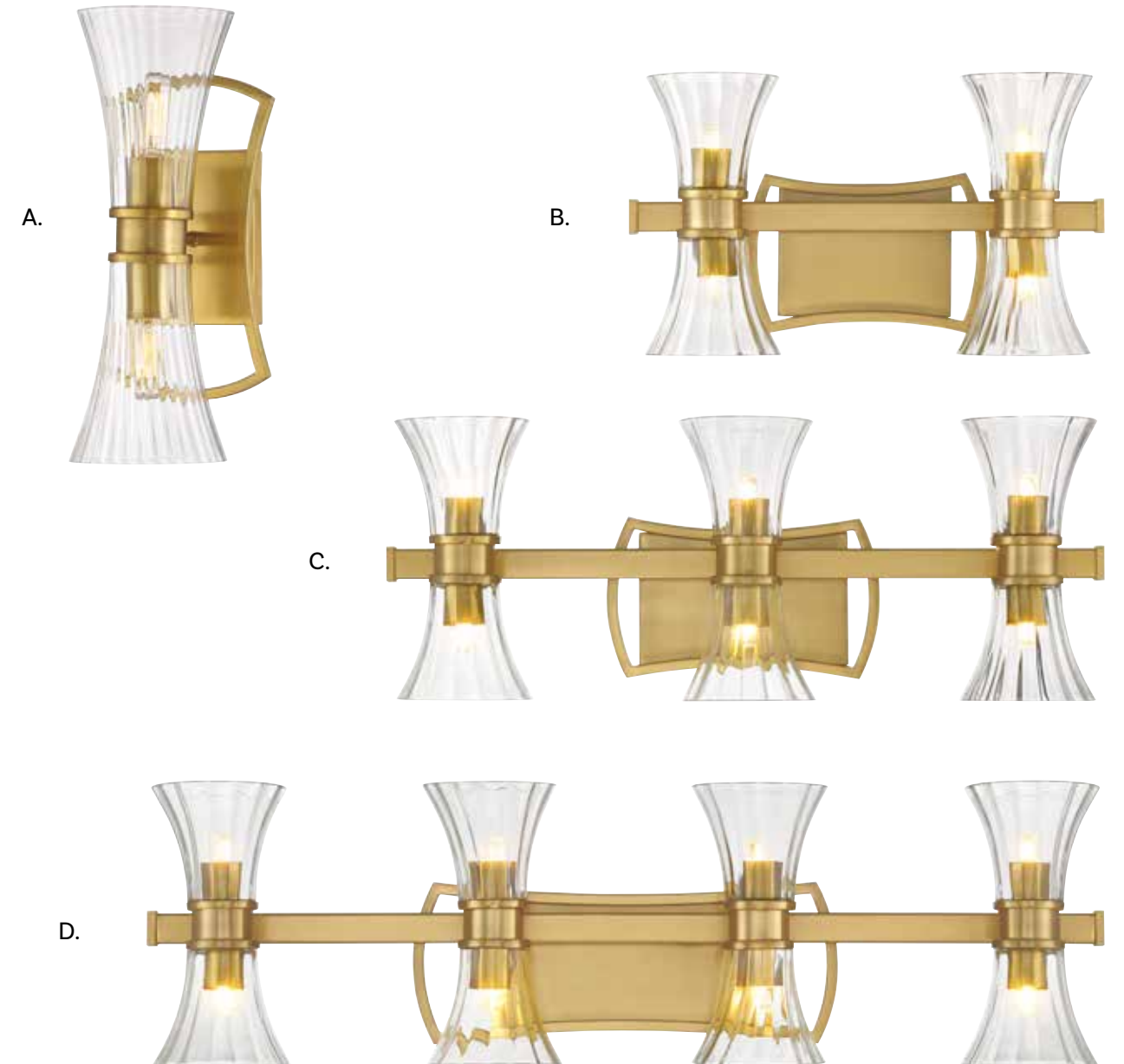

A. 9-9702-2-322
1-Light Sconce
Warm Brass Finish
6-1/4"W x 15"H x 6-1/2"E
2C 60W
Clear Ribbed Glass

B. 8-9702-4-322
4-Light Bath Bar
Warm Brass Finish
16"W x 8-3/4"H x 6"E
4G9 60W
Clear Ribbed Glass
G9 Bulbs Included

C. 8-9702-6-322
6-Light Bath Bar
Warm Brass Finish
24"W x 8-3/4"H x 6"E
6G9 60W
Clear Ribbed Glass
G9 Bulbs Included

D. 8-9702-8-322
8-Light Bath Bar
Warm Brass Finish
32"W x 8-3/4"H x 6"E
8G9 60W
Clear Ribbed Glass
G9 Bulbs Included



Fixtures may be mounted either uplight or downlight

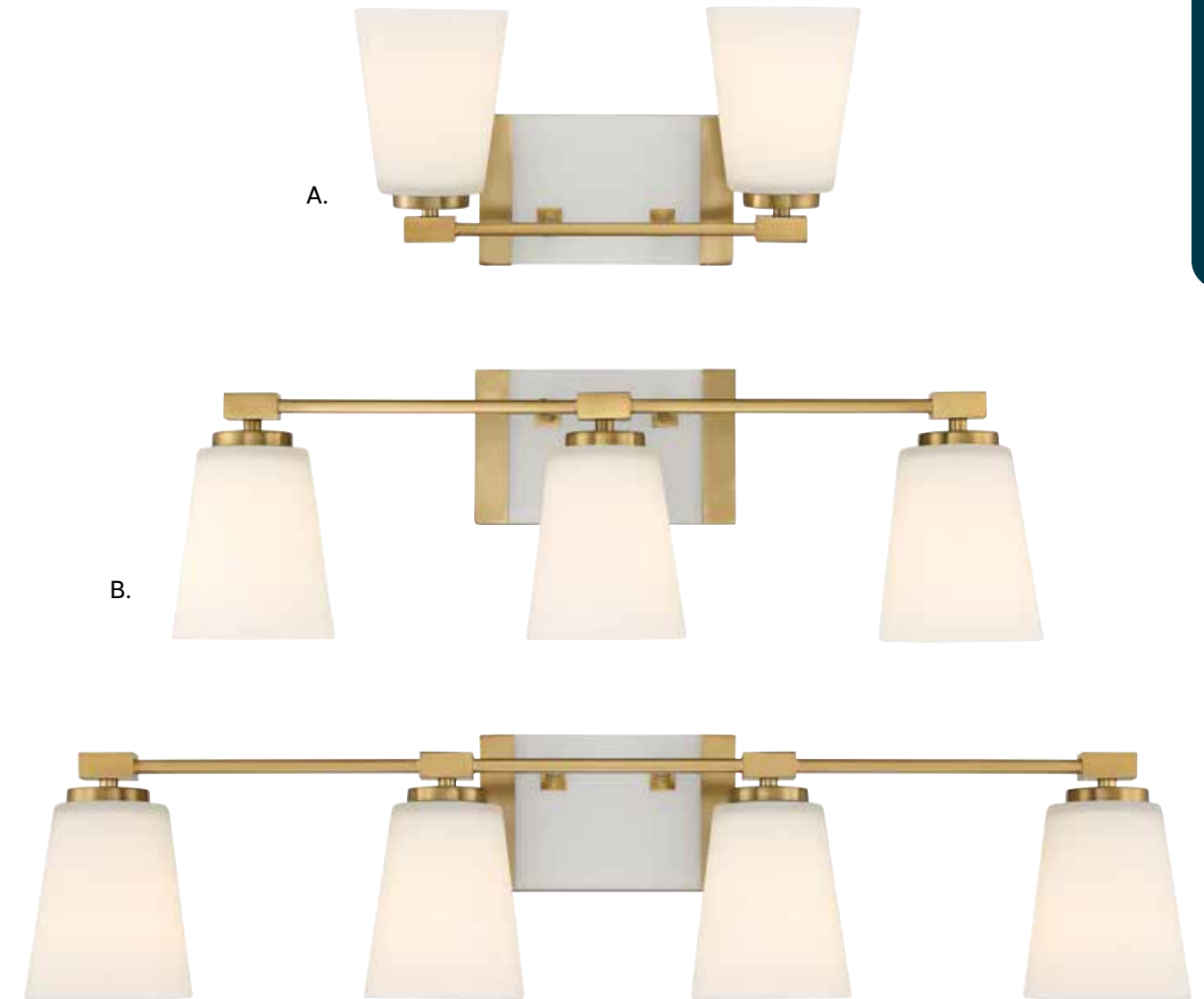

A. 8-6901-2-322
2-Light Bath Bar
Warm Brass Finish
15-1/4"W x 8"H x 7"E
2E 60W
White Opal Glass

B. 8-6901-3-322
3-Light Bath Bar
Warm Brass Finish
25-1/4"W x 8"H x 7"E
3E 60W
White Opal Glass

C. 8-6901-4-322
4-Light Bath Bar
Warm Brass Finish
34"W x 8"H x 7"E
4E 60W
White Opal Glass

POUR LE BAIN



POUR LE BAIN



A.

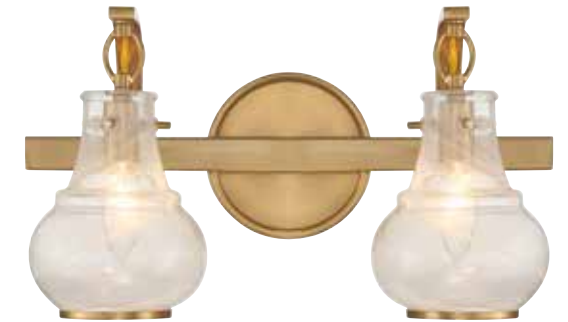

B.



C.



D.

A. 9-4417-1-322
1-Light Sconce
Warm Brass Finish
7"W x 11"H x 7-1/2"E
1E 60W
White Strie Glass

B. 8-4417-2-322
2-Light Bath Bar
Warm Brass Finish
15-1/2"W x 8-3/4"H x 7"E
2C 60W
White Strie Glass

C. 8-4417-3-322
3-Light Bath Bar
Warm Brass Finish
24"W x 8-3/4"H x 7"E
3C 60W
White Strie Glass

D. 8-4417-4-322
4-Light Bath Bar
Warm Brass Finish
32"W x 8-3/4"H x 7"E
4C 60W
White Strie Glass



A.



B.



C.



Fixtures may be mounted either uplight or downlight



A. 8-1720-2-143
 2-Light Bath Bar
 Matte Black w/
 Warm Brass Accents
 14-3/4"W x 8"H x 6-3/4"E
 2E 60W
 Clear Water Piastra Glass

B. 8-1720-3-143
 3-Light Bath Bar
 Matte Black w/
 Warm Brass Accents
 23"W x 8"H x 6-3/4"E
 3E 60W
 Clear Water Piastra Glass

C. 8-1720-4-143
 4-Light Bath Bar
 Matte Black w/
 Warm Brass Accents
 32"W x 8"H x 6-3/4"E
 4E 60W
 Clear Water Piastra Glass

POUR LE BAIN

POUR LE BAIN



A.



B.



C.



Fixtures may be mounted either uplight or downlight



A. 8-3600-2-322
2-Light Bath Bar
Warm Brass w/
Matte Black Accents
14"W x 8-3/4"H x 5"E
2E 60W
Crackled Glass

B. 8-3600-3-322
3-Light Bath Bar
Warm Brass w/
Matte Black Accents
22"W x 8-3/4"H x 5"E
3E 60W
Crackled Glass

C. 8-3600-4-322
4-Light Bath Bar
Warm Brass w/
Matte Black Accents
30"W x 8-3/4"H x 5"E
4E 60W
Crackled Glass

POUR LE BAIN



POUR LE BAIN



A.



B.



C.



D.

A. 9-1638-1-143
 1-Light Sconce
 Matte Black w/
 Warm Brass Accents
 5"W x 19-1/2"H x 4"E
 8W Integrated Dimmable LED
 300 Lumens, 3000K, 90+ CRI
 White Opal Glass

B. 8-1638-3-143
 3-Light Bath Bar
 Matte Black w/
 Warm Brass Accents
 21"W x 10"H x 5"E
 8W Integrated Dimmable LED
 790 Lumens, 3000K, 90+ CRI
 White Opal Glass

C. 8-1638-4-143
 4-Light Bath Bar
 Matte Black w/
 Warm Brass Accents
 30"W x 10"H x 5"E
 8W Integrated Dimmable LED
 1050 Lumens, 3000K, 90+ CRI
 White Opal Glass

D. 8-1638-5-143
 5-Light Bath Bar
 Matte Black w/
 Warm Brass Accents
 39"W x 10"H x 5"E
 8W Integrated Dimmable LED
 1200 Lumens, 3000K, 90+ CRI
 White Opal Glass

LED

POUR LE BAIN

POUR LE BAIN



A. 9-1977-1-143
1-Light Sconce
Matte Black w/
Warm Brass Accents
6"W x 8-1/4"H x 7"E
1E 60W
Clear Outer Glass
White Opal Chimney

B. 8-1977-2-143
2-Light Bath Bar
Matte Black w/
Warm Brass Accents
15"W x 7-1/2"H x 7-1/2"E
2E 60W
Clear Outer Glass
White Opal Chimney

C. 8-1977-3-143
3-Light Bath Bar
Matte Black w/
Warm Brass Accents
24"W x 7-1/2"H x 7-1/2"E
3E 60W
Clear Outer Glass
White Opal Chimney

D. 8-1977-4-143
4-Light Bath Bar
Matte Black w/
Warm Brass Accents
33"W x 7-1/2"H x 7-1/2"E
4E 60W
Clear Outer Glass
White Opal Chimney

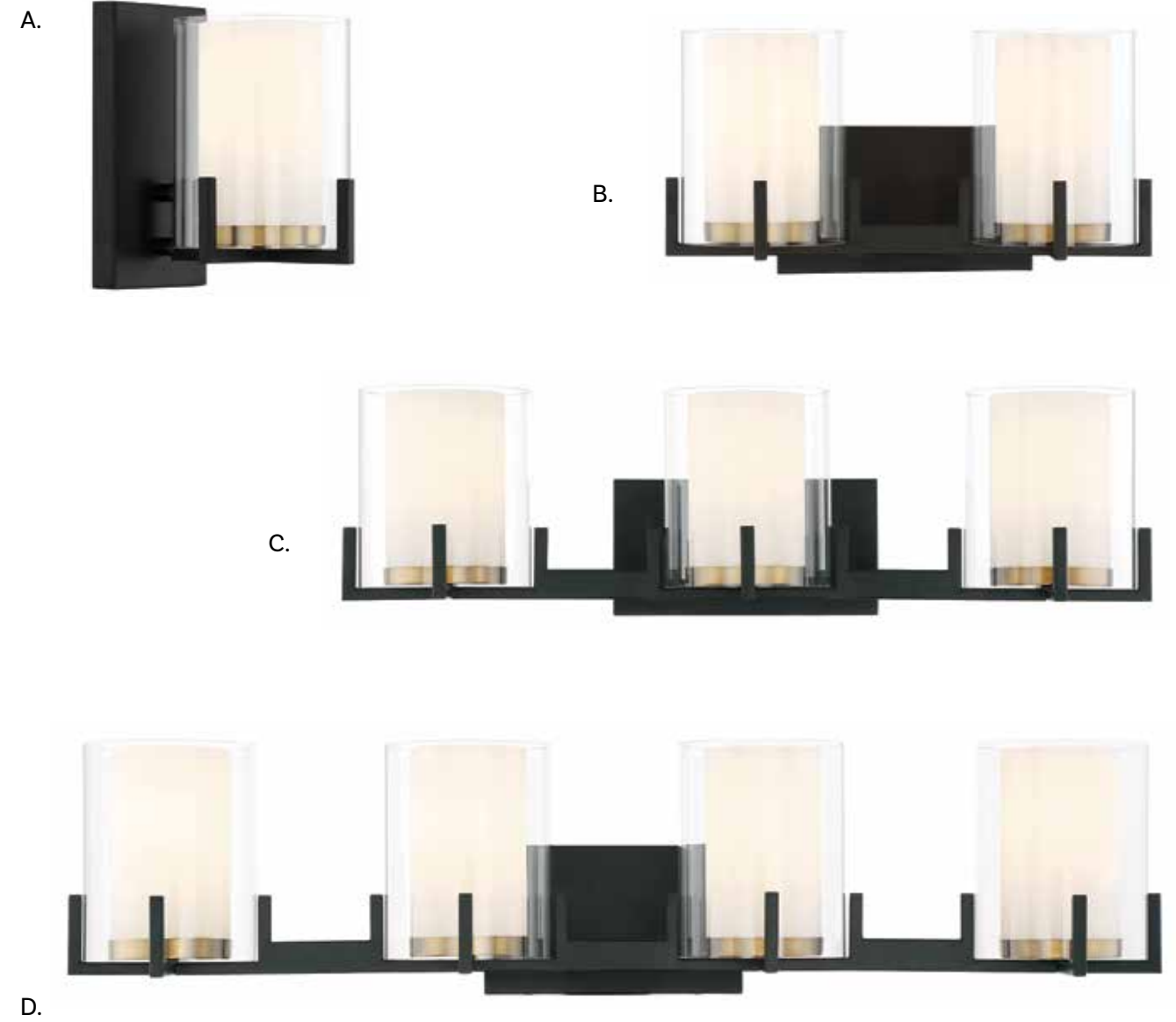

Ceiling, Page 318

Chandeliers, Page 116

POUR LE BAIN



POUR LE BAIN



A.

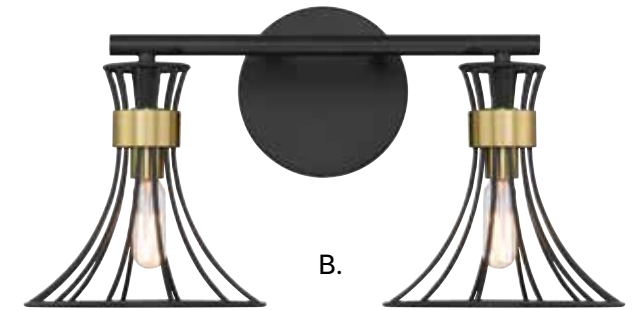

B.



C.

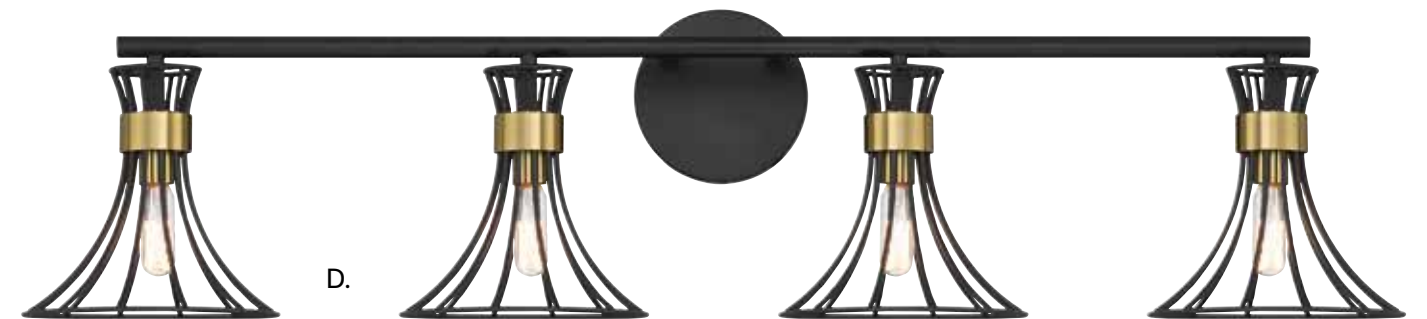

D.

A. 9-6080-1-143
1-Light Sconce
Matte Black w/
Warm Brass Accents
7"W x 9"H x 7-1/2"E
1C 60W

B. 8-6080-2-143
2-Light Bath Bar
Matte Black w/
Warm Brass Accents
17-1/4"W x 9"H x 7-1/2"E
2C 60W

C. 8-6080-3-143
3-Light Bath Bar
Matte Black w/
Warm Brass Accents
28"W x 9"H x 7-1/2"E
3C 60W

D. 8-6080-4-143
4-Light Bath Bar
Matte Black w/
Warm Brass Accents
38"W x 9"H x 7-1/2"E
4C 60W

MACAULEY

JAYLAR

POUR LE BAIN



- A. 8-2069-4-51**
4-Light Bath Bar
Vintage Black w/
Warm Brass Finish
32"W x 9-3/4"H x 6-3/4"E
4E 60W
Clear Glass
- B. 8-2069-2-51**
2-Light Bath Bar
Vintage Black w/
Warm Brass Finish
14-1/2"W x 9-3/4"H x 6-3/4"E
2E 60W
Clear Glass
- C. 8-2069-3-51**
3-Light Bath Bar
Vintage Black w/
Warm Brass Finish
24"W x 9-3/4"H x 6-3/4"E
3E 60W
Clear Glass

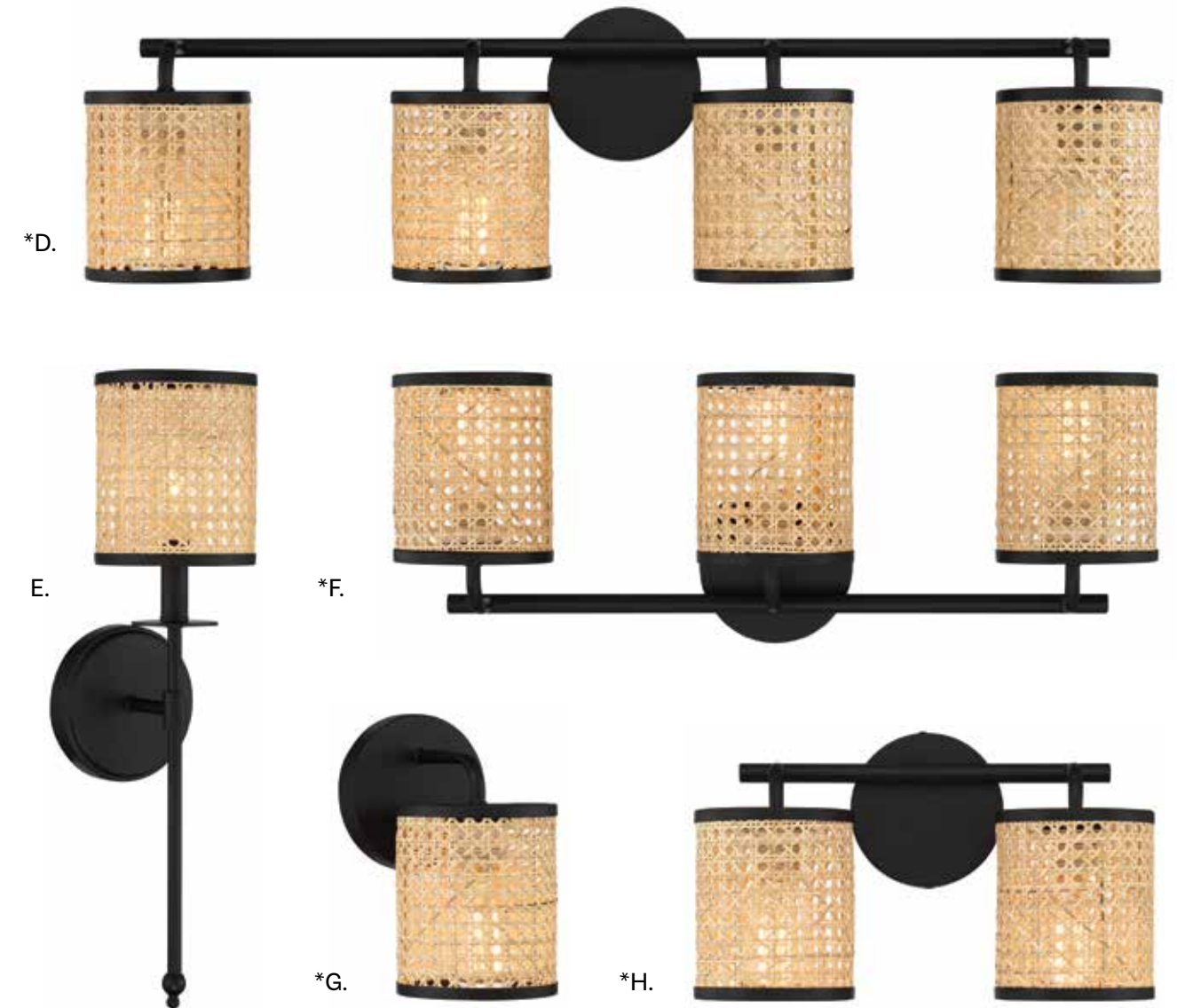

- D. 8-1648-4-BK**
4-Light Bath Bar
Matte Black Finish
34"W x 8-1/2"H x
6-3/4"E
4E 60W
Natural Cane Shade
- E. 9-1649-1-89**
1-Light Sconce
Matte Black Finish
5"W x 20"H x 6"E
1C 60W
Natural Cane Shade
- F. 8-1648-3-BK**
3-Light Bath Bar
Matte Black Finish
24-1/2"W x 8-1/2"H x
6-3/4"E
3E 60W
Natural Cane Shade
- G. 9-1648-1-89**
1-Light Sconce
Matte Black Finish
5"W x 9"H x 7"E
1E 60W
Natural Cane Shade
- H. 8-1648-2-BK**
2-Light Bath Bar
Matte Black Finish
15"W x 8-1/2"H x
6-3/4"E
2E 60W
Natural Cane Shade

*Fixtures may be mounted either upright or downlight

POUR LE BAIN

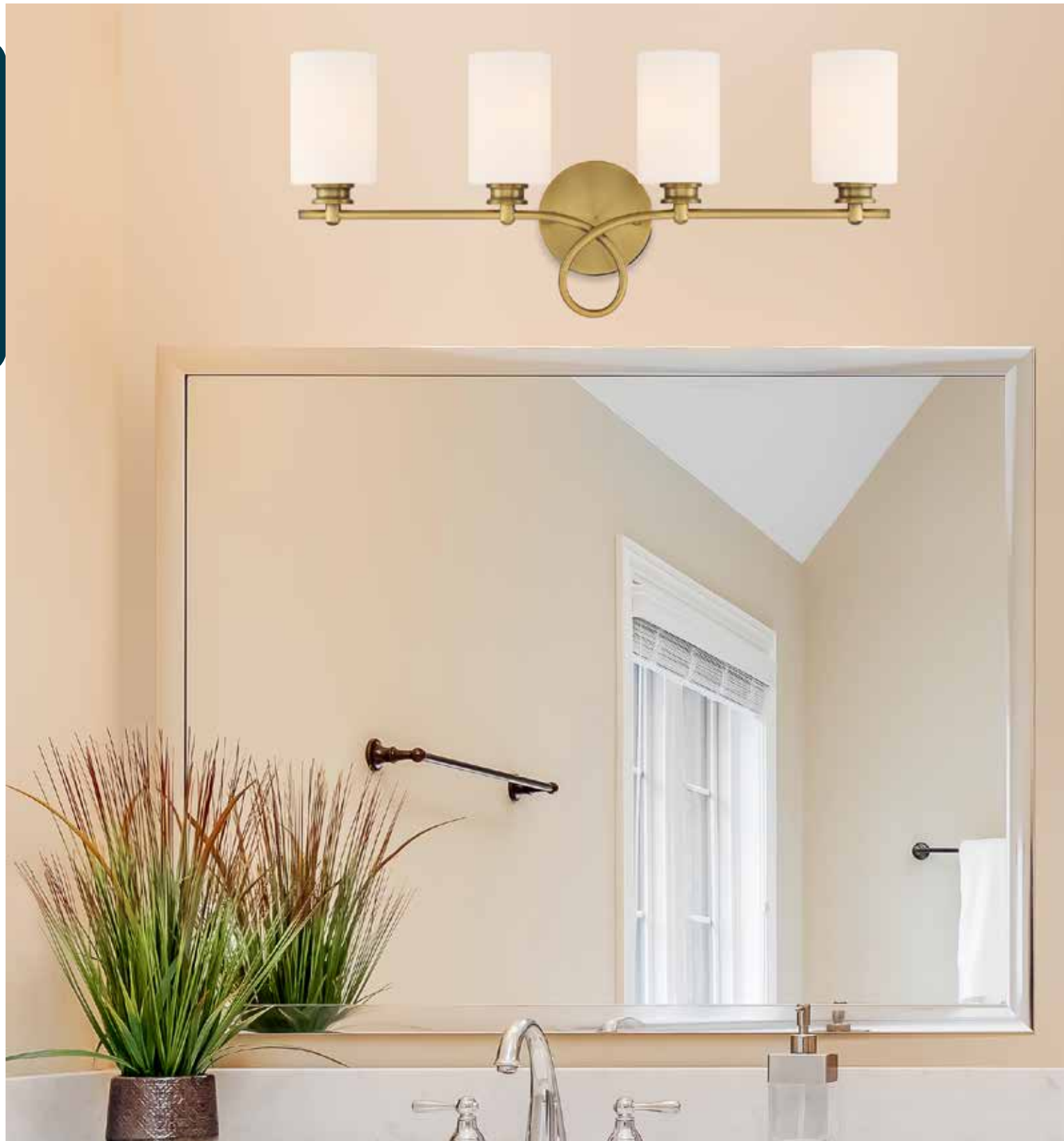

A.

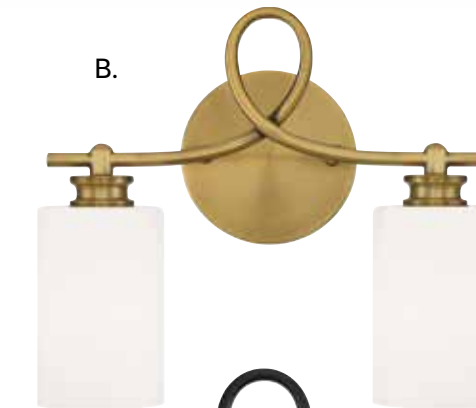

B.

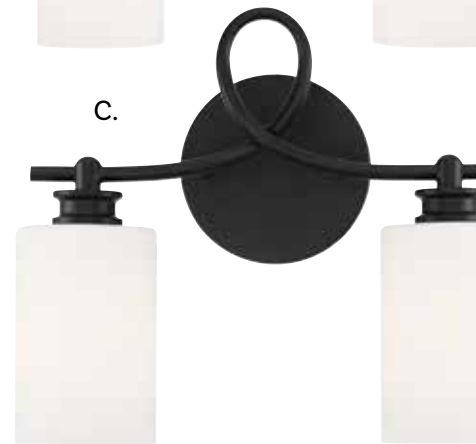

C.



D.

- A. 8-530-4-322**
4-Light Bath Bar
Warm Brass Finish
28"W x 12"H x 7"E
4E 60W
White Glass
- B. 8-530-2-322**
2-Light Bath Bar
Warm Brass Finish
14"W x 12"H x 7"E
2E 60W
White Glass
- C. 8-530-2-BK**
2-Light Bath Bar
Matte Black Finish
14"W x 12"H x 7"E
2E 60W
White Glass
- D. 8-530-4-BK**
4-Light Bath Bar
Matte Black Finish
28"W x 12"H x 7"E
4E 60W
White Glass

Fixtures may be mounted either uplight or downlight

POUR LE BAIN

POUR LE BAIN



- | | | | | | |
|---|---|---|---|---|---|
| A. 8-1724-4-143
4-Light Bath Bar
Matte Black w/
Warm Brass Accents
31"W x 6-1/2"H x 3-3/4"E
4C 60W
Clear Crystal | B. 8-1724-3-143
3-Light Bath Bar
Matte Black w/
Warm Brass Accents
23"W x 6-1/2"H x 3-3/4"E
3C 60W
Clear Crystal | C. 8-1724-2-143
2-Light Bath Bar
Matte Black w/
Warm Brass Accents
15"W x 6-1/2"H x 3-3/4"E
2C 60W
Clear Crystal | D. 8-1724-2-66
2-Light Bath Bar
Matte Black w/
Polished Nickel Accents
15"W x 6-1/2"H x 3-3/4"E
2C 60W
Clear Crystal | E. 8-1724-3-66
3-Light Bath Bar
Matte Black w/
Polished Nickel Accents
23"W x 6-1/2"H x 3-3/4"E
3C 60W
Clear Crystal | F. 8-1724-4-66
4-Light Bath Bar
Matte Black w/
Polished Nickel Accents
31"W x 6-1/2"H x 3-3/4"E
4C 60W
Clear Crystal |
|---|---|---|---|---|---|

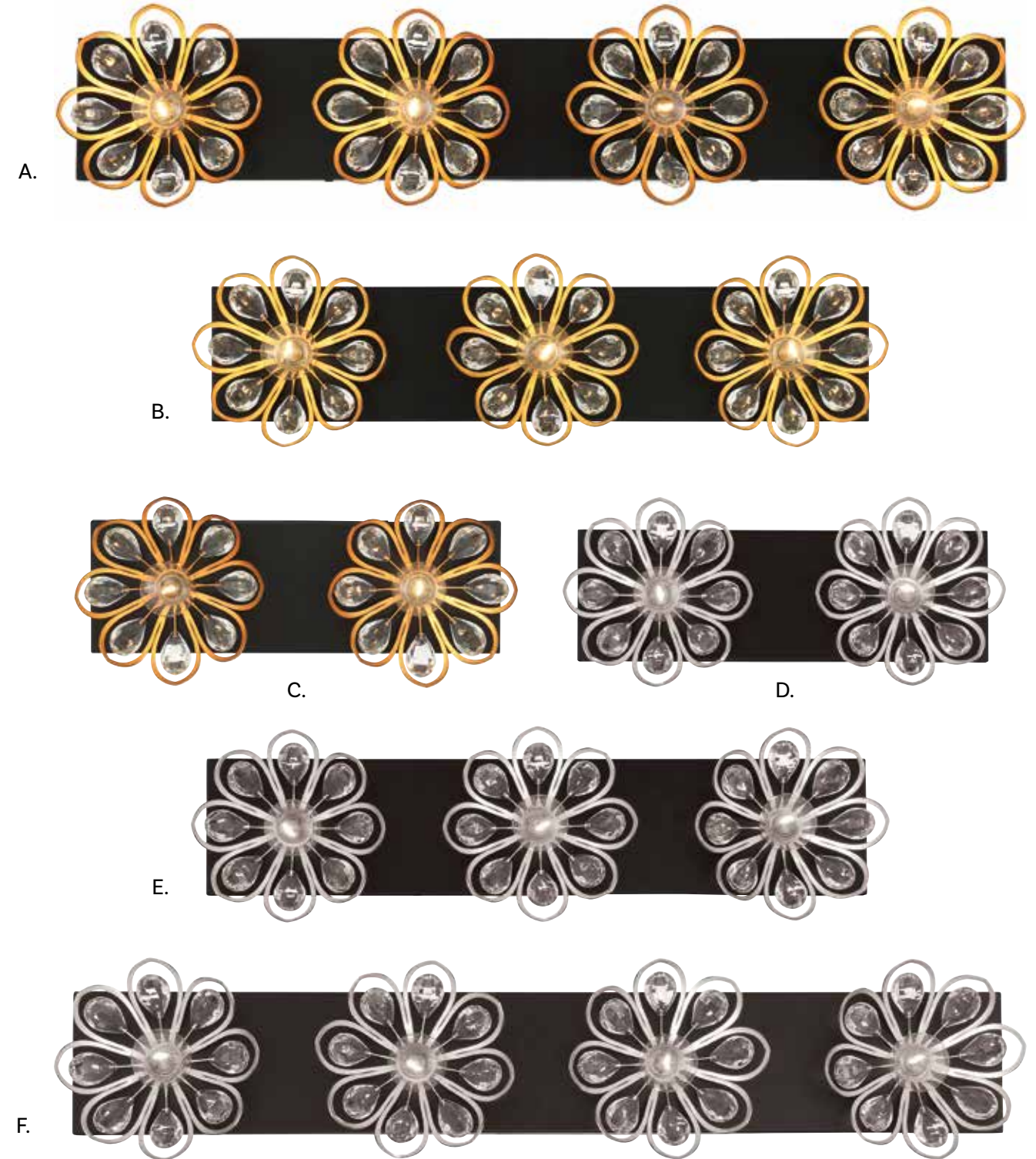

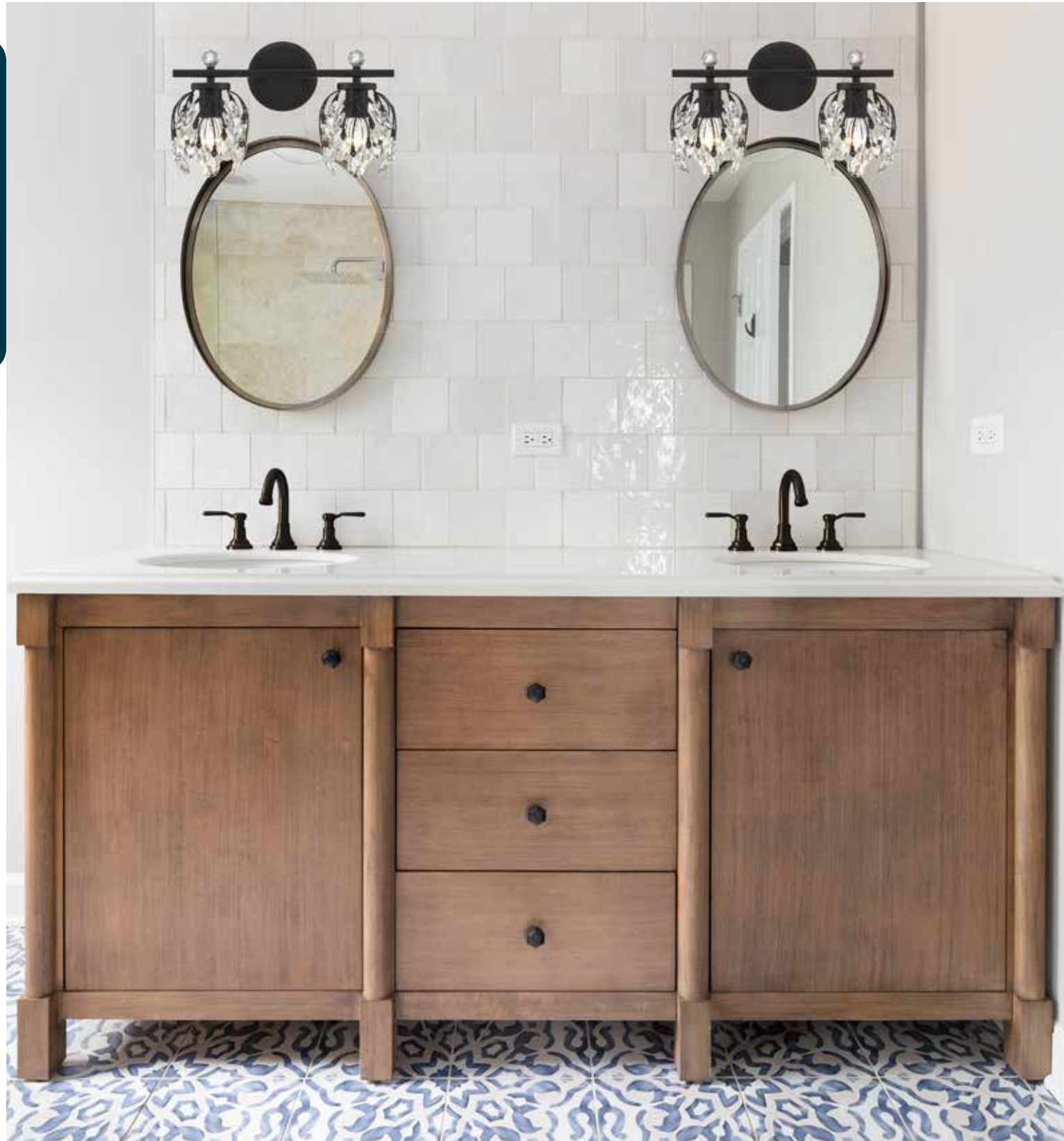

A. 8-6601-4-BK
4-Light Bath Bar
Matte Black Finish
31"W x 9-1/2"H
x 6-3/4"E
4E 60W
Clear Crystal



B. 8-6601-3-BK
3-Light Bath Bar
Matte Black Finish
23-1/2"W x 9-1/2"H
x 6-3/4"E
3E 60W
Clear Crystal



C. 8-6601-2-BK
2-Light Bath Bar
Matte Black Finish
15-1/2"W x 9-1/2"H
x 6-3/4"E
2E 60W
Clear Crystal

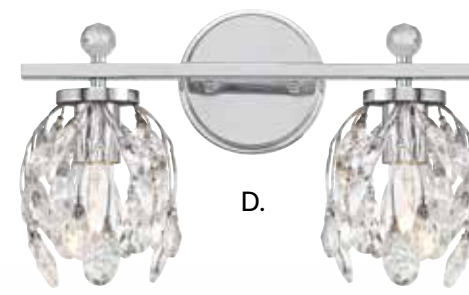

D. 8-6601-2-11
2-Light Bath Bar
Chrome Finish
15-1/2"W x 9-1/2"H
x 6-3/4"E
2E 60W
Clear Crystal



E. 8-6601-4-11
4-Light Bath Bar
Chrome Finish
31"W x 9-1/2"H
x 6-3/4"E
4E 60W
Clear Crystal



F. 8-6601-3-11
3-Light Bath Bar
Chrome Finish
23-1/2"W x 9-1/2"H
x 6-3/4"E
3E 60W
Clear Crystal

Fixtures may be mounted either uplight or downlight

HAMPTON

BIRONE

POUR LE BAIN

POUR LE BAIN



- A. 8-1972-2-322**
2-Light Bath Bar
Warm Brass Finish
16"W x 8-3/4"H x 6-1/2"E
2E 60W
Clear Crackled Glass
- B. 8-1972-3-322**
3-Light Bath Bar
Warm Brass Finish
24"W x 8-3/4"H x 6-1/2"E
3E 60W
Clear Crackled Glass
- C. 9-1972-1-322**
1-Light Sconce
Warm Brass Finish
4-3/4"W x 9-7/8"H x 6-1/2"E
1E 60W
Clear Crackled Glass
- D. 8-1972-4-322**
4-Light Bath Bar
Warm Brass Finish
32"W x 8-3/4"H x 6-1/2"E
4E 60W
Clear Crackled Glass

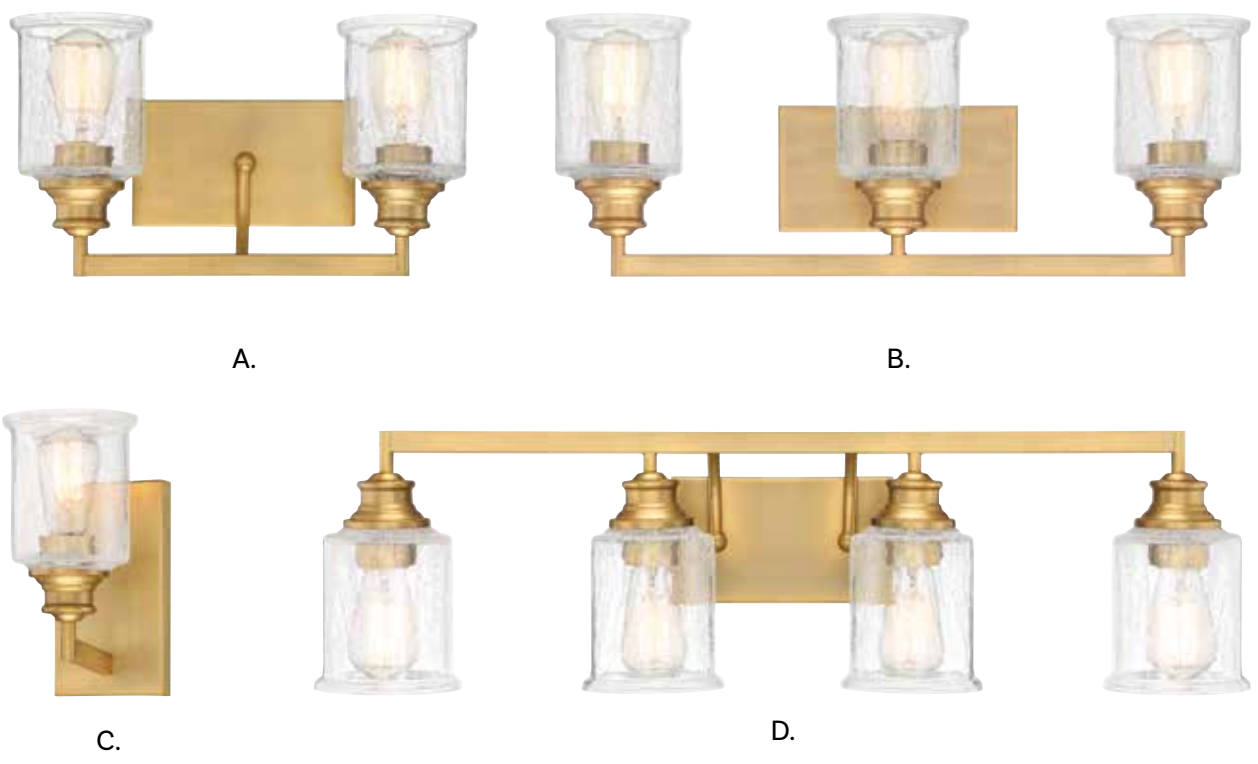

- E. 8-880-2-109**
2-Light Bath Bar
Polished Nickel Finish
16"W x 8-1/2"H x 6-3/4"E
2E 60W
Clear Crystal Glass
Crystal Accents
- F. 8-880-3-109**
3-Light Bath Bar
Polished Nickel Finish
24"W x 8-1/2"H x 6-3/4"E
3E 60W
Clear Crystal Glass
Crystal Accents
- G. 9-880-1-109**
1-Light Sconce
Polished Nickel Finish
6"W x 8-1/2"H x 7-1/2"E
1E 60W
Clear Crystal Glass
Crystal Accent
- H. 8-880-4-109**
4-Light Bath Bar
Polished Nickel Finish
33"W x 8-1/2"H x 6-3/4"E
4E 60W
Clear Crystal Glass
Crystal Accents

Fixtures may be mounted either uplight or downlight

Fixtures may be mounted either uplight or downlight

POUR LE BAIN



POUR LE BAIN



A. 8-1909-2-66
2-Light Bath Bar
Matte Black w/
Satin Nickel Accents
15-1/2"W x 7"H x 6"E
2E 60W
Clear Hobnail Glass

B. 8-1909-3-66
3-Light Bath Bar
Matte Black w/
Satin Nickel Accents
24"W x 7"H x 6"E
3E 60W
Clear Hobnail Glass

C. 8-1909-4-66
4-Light Bath Bar
Matte Black w/
Satin Nickel Accents
32"W x 7"H x 6"E
4E 60W
Clear Hobnail Glass

Fixtures may be mounted either uplight or downlight

POUR LE BAIN

POUR LE BAIN



- | | | | | | |
|---|---|---|--|--|--|
| A. 8-560-4-BK
4-Light Bath Bar
Matte Black Finish
32"W x 11-3/8"H x
7-5/8"E
4E 60W
Clear Water Glass | B. 8-560-3-BK
3-Light Bath Bar
Matte Black Finish
24"W x 11-3/8"H x
7-5/8"E
3E 60W
Clear Water Glass | C. 8-560-2-BK
2-Light Bath Bar
Matte Black Finish
16"W x 11-3/8"H x
6-3/4"E
2E 60W
Clear Water Glass | D. 8-560-4-11
4-Light Bath Bar
Polished
Chrome Finish
32"W x 11-3/8"H x
7-5/8"E
4E 60W
Clear Water Glass | E. 8-560-3-11
3-Light Bath Bar
Polished
Chrome Finish
24"W x 11-3/8"H x
7-5/8"E
3E 60W
Clear Water Glass | F. 8-560-2-11
2-Light Bath Bar
Polished
Chrome Finish
16"W x 11-3/8"H x
6-3/4"E
2E 60W
Clear Water Glass |
|---|---|---|--|--|--|



VAUGHAN

REDMOND

POUR LE BAIN

POUR LE BAIN

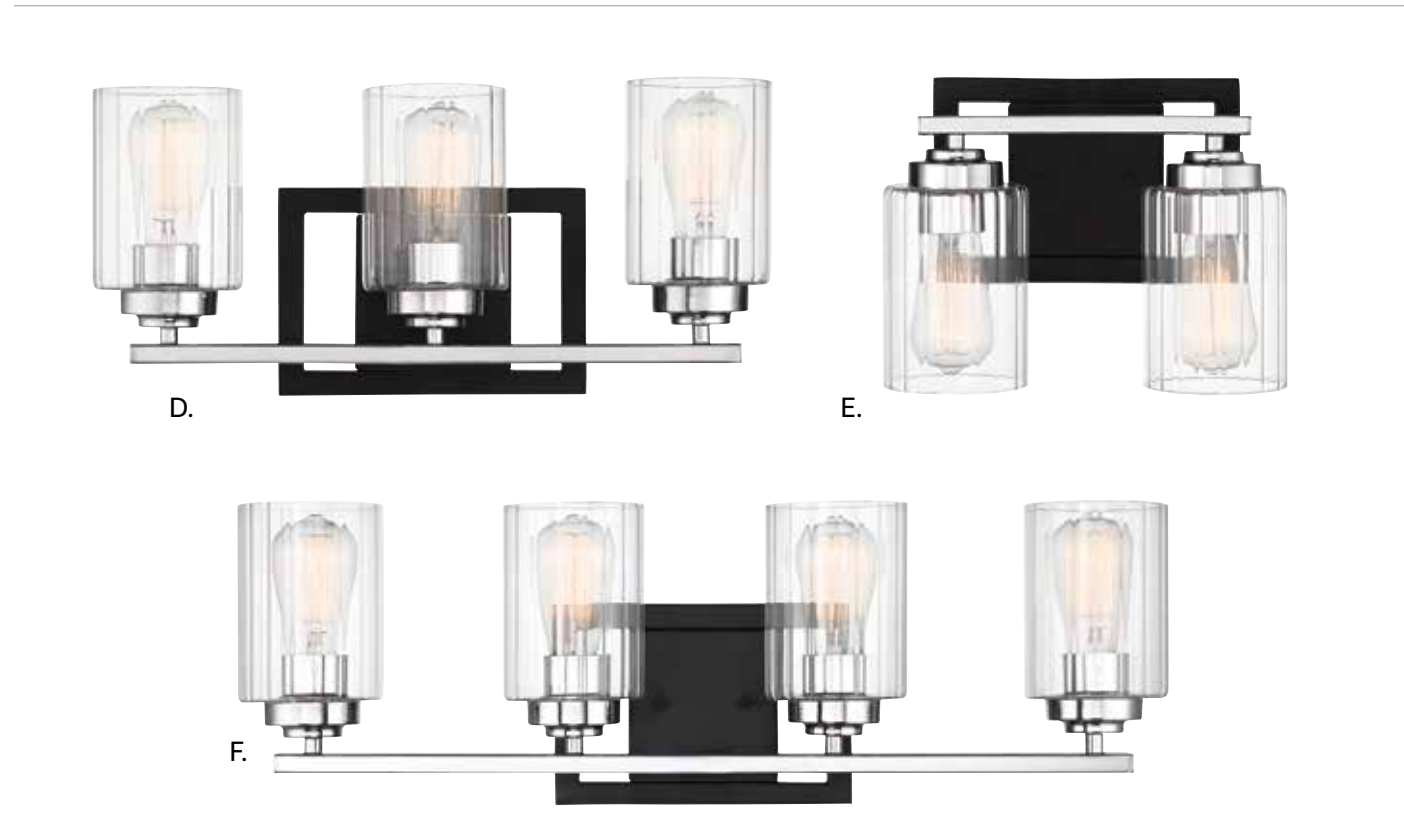

- A. 8-4508-4-SN**
4-Light Bath Bar
Satin Nickel Finish
32-1/2"W x 9-1/4"H x 6"E
4E 60W
Clear Water Glass
- B. 8-4508-3-SN**
3-Light Bath Bar
Satin Nickel Finish
23-3/4"W x 9-1/4"H x 6"E
3E 60W
Clear Water Glass
- C. 8-4508-2-SN**
2-Light Bath Bar
Satin Nickel Finish
14-1/4"W x 9-1/4"H x 6"E
2E 60W
Clear Water Glass

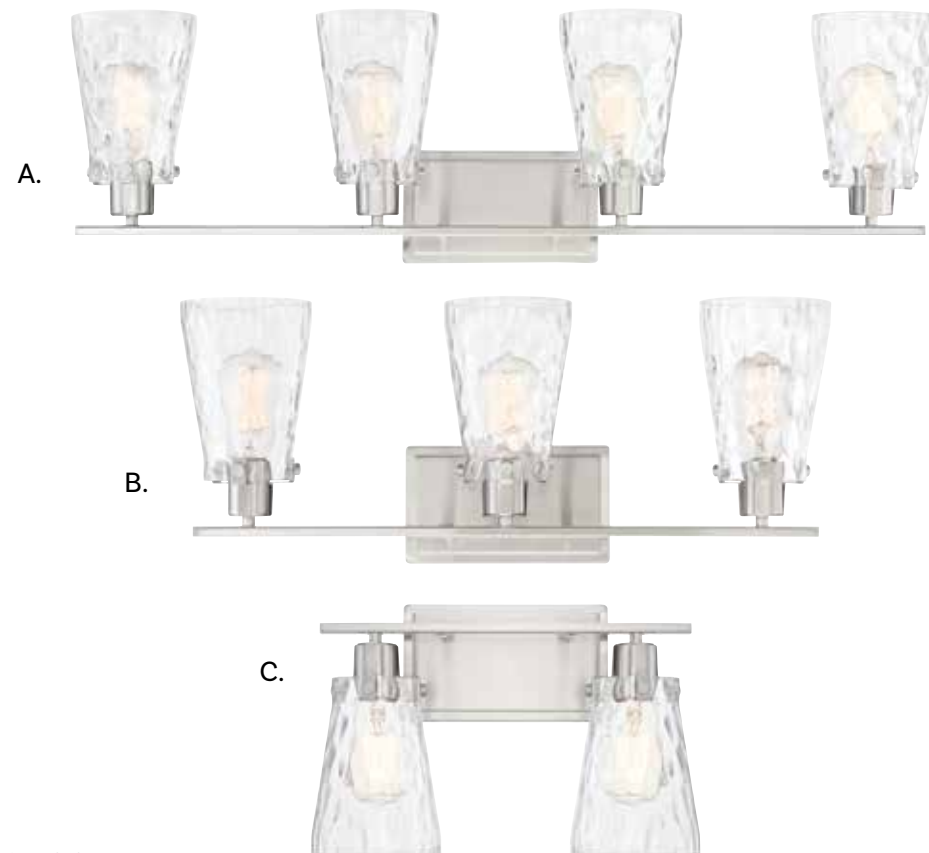

- D. 8-2154-3-67**
3-Light Bath Bar
Matte Black w/
Polished Chrome Accents
20"W x 9-1/4"H x 6"E
3E 60W
Clear Ribbed Glass
- E. 8-2154-2-67**
2-Light Bath Bar
Matte Black w/
Polished Chrome Accents
12"W x 9-1/4"H x 6"E
2E 60W
Clear Ribbed Glass
- F. 8-2154-4-67**
4-Light Bath Bar
Matte Black w/
Polished Chrome Accents
28"W x 9-1/4"H x 6"E
4E 60W
Clear Ribbed Glass



Fixtures may be mounted either uplight or downlight

BRANNON

LAMBERT

POUR LE BAIN

POUR LE BAIN



- A. 8-2148-2-109**
2-Light Bath Bar
Polished Nickel Finish
14-3/8"W x 8-5/8"H x 6-1/2"E
2E 60W
Clear Glass
K9 Crystal Accent
- B. 8-2148-3-109**
3-Light Bath Bar
Polished Nickel Finish
24"W x 8-5/8"H x 6-1/2"E
3E 60W
Clear Glass
K9 Crystal Accent
- C. 8-2148-4-109**
4-Light Bath Bar
Polished Nickel Finish
33-5/8"W x 8-5/8"H x 6-1/2"E
4E 60W
Clear Glass
K9 Crystal Accent



Fixtures may be mounted either uplight or downlight

- D. 8-2149-3-11**
3-Light Bath Bar
Polished Chrome Finish
22"W x 9-3/4"H x 6"E
3E 60W
Clear Glass
- E. 8-2149-2-11**
2-Light Bath Bar
Polished Chrome Finish
13-1/2"W x 9-3/4"H x 6"E
2E 60W
Clear Glass
- F. 8-2149-4-11**
4-Light Bath Bar
Polished Chrome Finish
30-7/8"W x 9-3/4"H x 6"E
4E 60W
Clear Glass



POUR LE BAIN

POUR LE BAIN

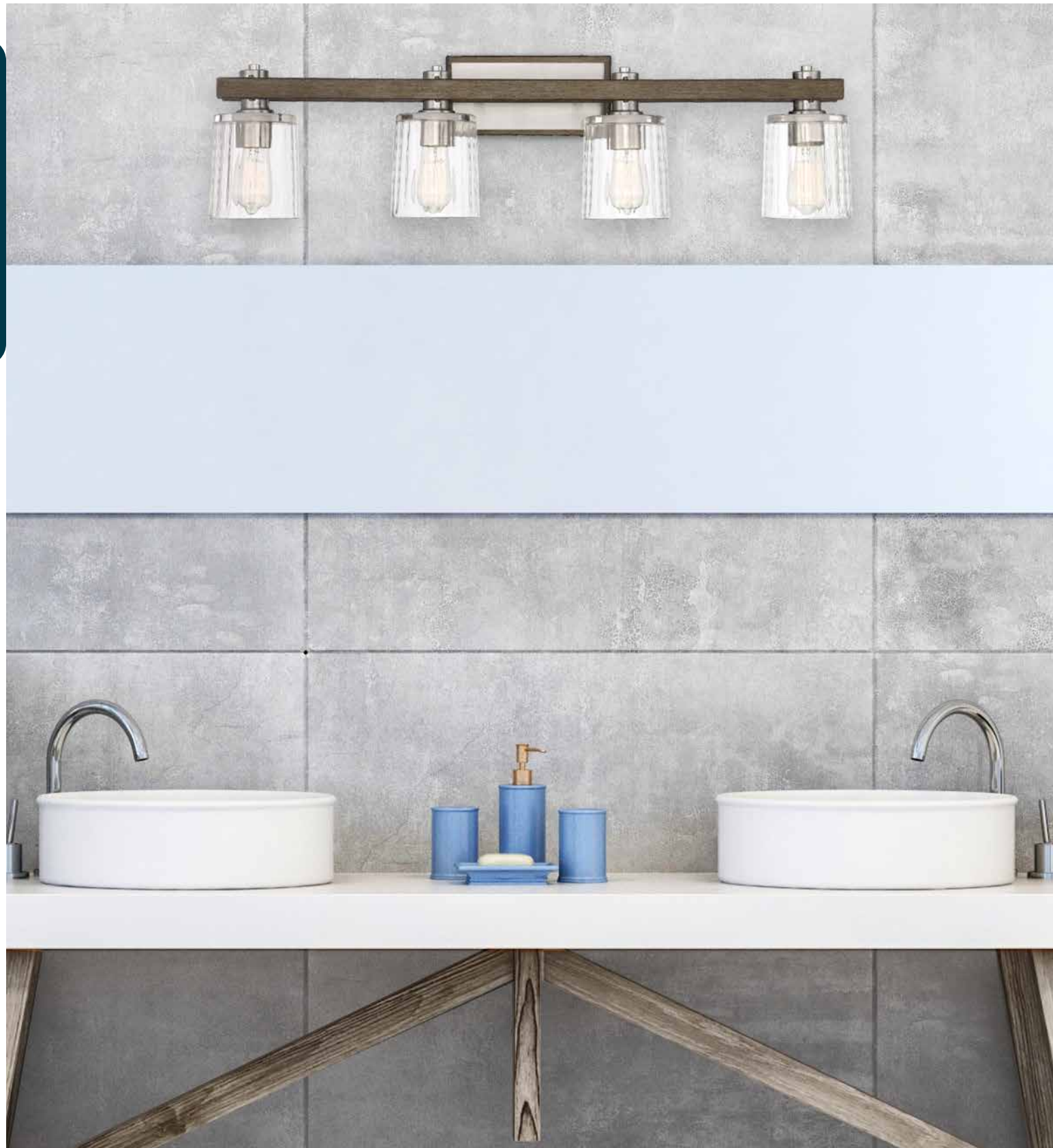

A.



A. 8-1255-4-41
4-Light Bath Bar
Durango Finish
36W x 9-3/4"H x 7"E
4E 60W
Clear Rippled Glass



B.

B. 8-1255-3-41
3-Light Bath Bar
Durango Finish
25"W x 9-3/4"H x 7"E
3E 60W
Clear Rippled Glass



C.

C. 8-1255-2-41
2-Light Bath Bar
Durango Finish
15"W x 9-3/4"H x 7"E
2E 60W
Clear Rippled Glass

D.



D. 8-1255-4-165
4-Light Bath Bar
Satin Nickel w/
Gray Wood
36W x 9-3/4"H x 7"E
4E 60W
Clear Rippled Glass



E.

E. 8-1255-3-165
3-Light Bath Bar
Satin Nickel w/
Gray Wood
25"W x 9-3/4"H x 7"E
3E 60W
Clear Rippled Glass



F.

F. 8-1255-2-165
2-Light Bath Bar
Satin Nickel w/
Gray Wood
15"W x 9-3/4"H x 7"E
2E 60W
Clear Rippled Glass

Fixtures may be mounted either upright or downlight

BURGESS

POUR LE BAIN

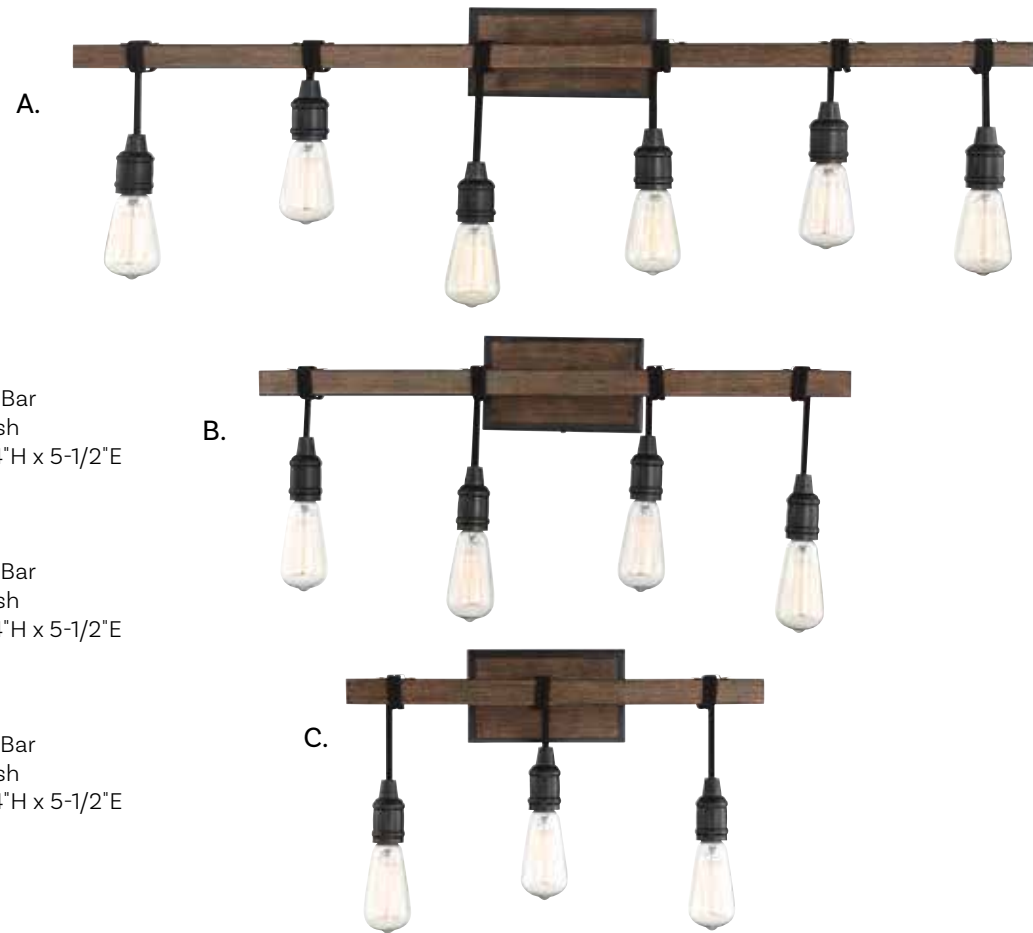

- A. 8-993-6-41**
6-Light Bath Bar
Durango Finish
39"W x 10-1/4"H x 5-1/2"E
6E 60W
- B. 8-993-4-41**
4-Light Bath Bar
Durango Finish
28"W x 10-1/4"H x 5-1/2"E
4E 60W
- C. 8-993-3-41**
3-Light Bath Bar
Durango Finish
20"W x 10-1/4"H x 5-1/2"E
3E 60W



LANSING

POUR LE BAIN



- D. 8-1780-2-111**
2-Light Bath Bar
Satin Nickel w/
Polished Nickel Accents
13-1/2"W x 10"H x 7"E
2E 60W
Clear Glass
- E. 8-1780-3-111**
3-Light Bath Bar
Satin Nickel w/
Polished Nickel Accents
24"W x 10"H x 7"E
3E 60W
Clear Glass
- F. 8-1780-3-79**
3-Light Bath Bar
English Bronze w/
Warm Brass Finish
24"W x 10"H x 7"E
3E 60W
Clear Glass
- G. 8-1780-2-79**
2-Light Bath Bar
English Bronze w/
Warm Brass Finish
13-1/2"W x 10"H x 7"E
2E 60W
Clear Glass





A.



A. 6-1685-1-142
1-Light Semi-Flush
White w/
Warm Brass Accents
20"W x 9"H
1E 60W
White Opal Glass

B.



B. 6-1685-1-175
1-Light Semi-Flush
Gray w/ Polished
Nickel Accents
20"W x 9"H
1E 60W
White Opal Glass

C.



C. 6-1685-1-143
1-Light Semi-Flush
Matte Black w/
Warm Brass Accents
20"W x 9"H
1E 60W
White Opal Glass



Pendant, Page 216

CEILING

CEILING



A. EATON
6-1981-1-143
 1-Light Semi-Flush
 Matte Black w/
 Warm Brass Accents
 17"W x 10-1/4"H
 1E 60W
 Clear & White Opal Glass

B. HAYWARD
6-1695-4-143
 4-Light Semi-Flush
 Matte Black w/
 Warm Brass Accents
 24"W x 8"H
 4E 60W
 Strie Piastra Glass

C. DAUPHIN
6-9985-3-94
 3-Light Convertible
 Semi-Flush/Pendant
 Avignon Finish
 18-3/4"W x 26-3/4"H
 3C 60W
 Soft Ivory Drip Candle Covers
 Wooden Beads



Convertible:
 Semi-Flush/Pendant

CEILING

CEILING



D. SCOUT
6-8074-15-SN
 15" Flush Mount
 Satin Nickel Finish
 15"W x 6-1/2"H
 3E 60W
UL Damp Rated

E. SCOUT
6-8074-15-13
 15" Flush Mount
 English Bronze Finish
 15"W x 6-1/2"H
 3E 60W
UL Damp Rated

F. GLENWOOD
6-3042-4-13
 4-Light Semi-Flush
 English Bronze Finish
 14"W x 13-3/4"H
 4C 60W
 Clear Water Piastra Glass



1-1130-8-13
 8-Light Outdoor Chandelier
 English Bronze Finish
 32"W x 27-5/8"H
 8E 60W
 Clear Glass
UL Damp Rated

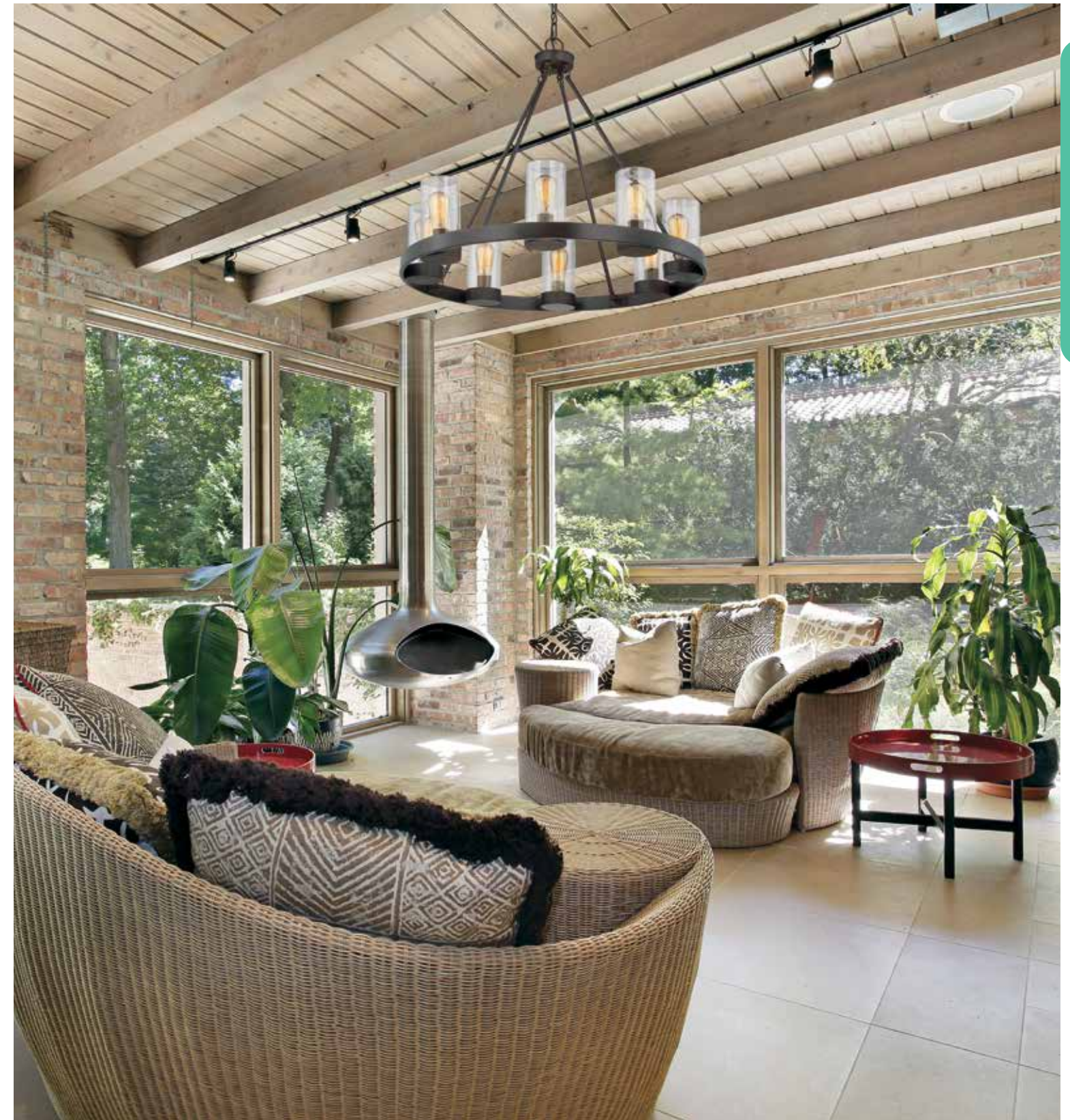

Includes 120" chain & wire



1-2100-6-70
6-Light Outdoor Chandelier
Weathervane Finish
29"W x 30-1/2"H
6C 60W
Clear Glass
UL Damp Rated

Includes 120" chain & wire



A.

B.



Adjustable Shutters - Closed

Adjustable Shutters - Closed



A. 9-9342-1-162
 1-Light Outdoor Wall Lantern
 Aged Driftwood Finish
 9"W x 13"H x 5"E
 1C 60W
 Clear Glass Bulb Covers
 Adjustable Shutters
UL Damp Location

B. 9-9343-2-162
 2-Light Outdoor Wall Lantern
 Aged Driftwood Finish
 12"W x 18"H x 5"E
 2C 60W
 Clear Glass Bulb Covers
 Adjustable Shutters
UL Damp Location

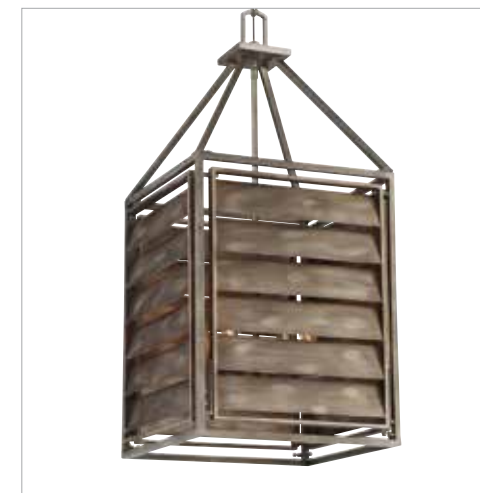

Adjustable Shutters - Closed



7-9341-4-162
 4-Light Outdoor Pendant
 Aged Driftwood Finish
 20-1/2"W x 31"H
 4C 60W
 Clear Glass Bulb Covers
 Adjustable Shutters
UL Damp Location

Includes 120" chain & wire

MONTPELIER

MONTPELIER

OUTDOOR



OUTDOOR

*A.



C.



D.



A. 5-763-BK
3-Light Outdoor
Hanging Lantern
Matte Black Finish
7-1/2"W x 25"H
3C 40W
Clear Seeded Glass

B. 5-769-BK
3-Light Outdoor
Post Lantern
Matte Black Finish
7-1/2"W x 29"H
3C 60W
Clear Seeded Glass

C. 5-766-BK
2-Light Outdoor
Wall Lantern
Matte Black Finish
6-1/4"W x 22"H x 8-1/4"E
2C 40W
Clear Seeded Glass

D. 5-764-BK
4-Light Outdoor
Wall Lantern
Matte Black Finish
9-1/2"W x 32"H x 12"E
4C 40W
Clear Seeded Glass

E. 5-765-BK
3-Light Outdoor
Wall Lantern
Matte Black Finish
7-1/2"W x 25"H x 10"E
3C 40W
Clear Seeded Glass

F. 5-768-BK
1-Light Outdoor
Wall Lantern
Matte Black Finish
5-1/2"W x 18-1/2"H x 7-1/2"E
1E 60W
Clear Seeded Glass

B.



E.



F.



*Includes 120" chain & wire

OUTDOOR



OUTDOOR

*A.



C.



D.



B.



E.



F.



A. 5-717-143
2-Light Outdoor
Hanging Lantern
Matte Black w/
Warm Brass Accents
8-1/2"W x 22-1/2"H
2C 40W
Clear Seeded Glass

B. 5-718-143
2-Light Outdoor
Post Lantern
Matte Black w/
Warm Brass Accents
8-1/2"W x 22-1/2"H
2C 60W
Clear Seeded Glass

C. 5-714-143
2-Light Outdoor
Wall Lantern
Matte Black w/
Warm Brass Accents
8-1/2"W x 20-1/4"H x
9-3/4"E
2C 40W
Clear Seeded Glass

D. 5-716-143
4-Light Outdoor
Wall Lantern
Matte Black w/
Warm Brass Accents
11-1/2"W x 28"H x 13"E
4C 40W
Clear Seeded Glass

E. 5-715-143
3-Light Outdoor
Wall Lantern
Matte Black w/
Warm Brass Accents
10"W x 25-1/4"H x 11-1/2"E
3C 40W
Clear Seeded Glass

F. 5-719-143
1-Light Outdoor
Wall Lantern
Matte Black w/
Warm Brass Accents
7"W x 16-1/4"H x 8-1/4"E
1E 60W
Clear Seeded Glass

*Includes 120" chain & wire

OUTDOOR

OUTDOOR



*A.



B.

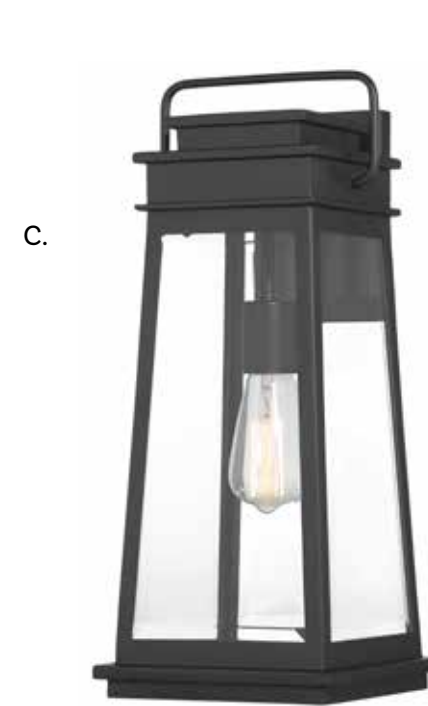

C.



E.



D.



F.

A. 5-816-BK
1-Light Outdoor
Hanging Lantern
Matte Black Finish
8-1/4"W x 22"H
1E 60W
Clear Beveled Glass

B. 5-817-BK
1-Light Outdoor
Post Lantern
Matte Black Finish
8-1/4"W x 24-1/4"H
1E 60W
Clear Beveled Glass

C. 5-813-BK
1-Light Outdoor
Wall Lantern
Matte Black Finish
8-1/4"W x 20"H x 8-1/2"E
1E 60W
Clear Beveled Glass

D. 5-815-BK
4-Light Outdoor
Wall Lantern
Matte Black Finish
13-1/4"W x 32"H x 13-1/2"E
4C 40W
Clear Beveled Glass

E. 5-814-BK
1-Light Outdoor
Wall Lantern
Matte Black Finish
10-1/4"W x 24-3/4"H x 11-1/2"E
1E 60W
Clear Beveled Glass

F. 5-812-BK
1-Light Outdoor
Wall Lantern
Matte Black Finish
6-1/4"W x 15-1/4"H x 6-1/2"E
1E 60W
Clear Beveled Glass

*Includes 120" chain & wire



*Includes 120" chain & wire



- A. 5-357-BK**
LED Outdoor
Hanging Lantern
Matte Black Finish
7-1/4" W x 21-3/4" H
4.5W Integrated Dimmable LED
90 Lumens, 3000K, 90+ CRI
Clear Seeded Glass
- B. 5-356-BK**
LED Outdoor
Post Lantern
Matte Black Finish
7-1/4" W x 22-1/2" H
4.5W Integrated Dimmable LED
90 Lumens, 3000K, 90+ CRI
Clear Seeded Glass
- C. 5-353-BK**
LED Outdoor
Wall Lantern
Matte Black Finish
6-1/2" W x 17-1/2" H x 7-3/4" E
4.5W Integrated Dimmable LED
90 Lumens, 3000K, 90+ CRI
Clear Seeded Glass
- D. 5-355-BK**
LED Outdoor
Wall Lantern
Matte Black Finish
12" W x 32-1/4" H x 14" E
14W Integrated Dimmable LED
317 Lumens, 3000K, 90+ CRI
Clear Seeded Glass
- E. 5-354-BK**
LED Outdoor
Wall Lantern
Matte Black Finish
7-1/4" W x 20" H x 9" E
4.5W Integrated Dimmable LED
90 Lumens, 3000K, 90+ CRI
Clear Seeded Glass
- F. 5-352-BK**
LED Outdoor
Wall Lantern
Matte Black Finish
5-1/2" W x 15" H x 6-3/4" E
4.5W Integrated Dimmable LED
90 Lumens, 3000K, 90+ CRI
Clear Seeded Glass



OUTDOOR



OUTDOOR

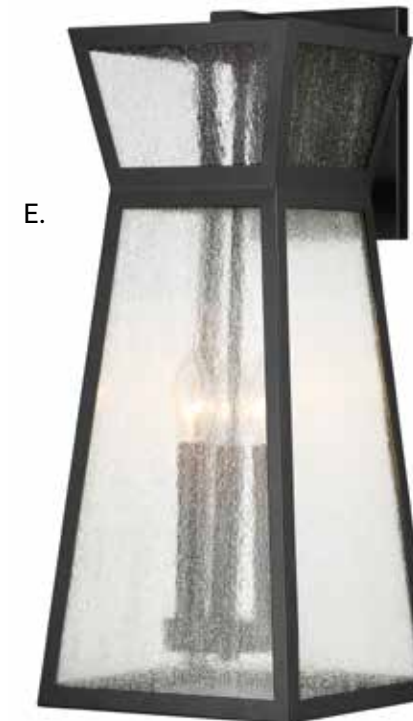
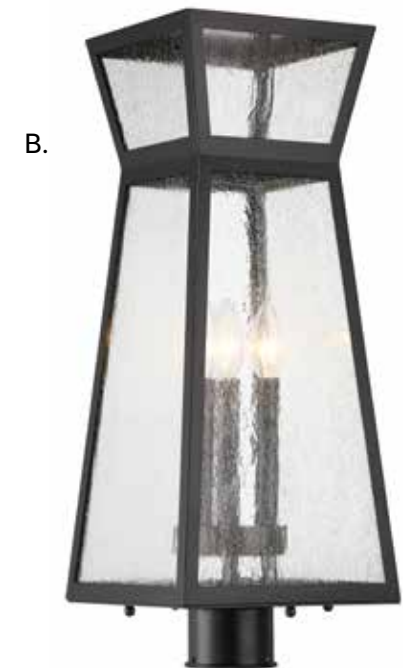
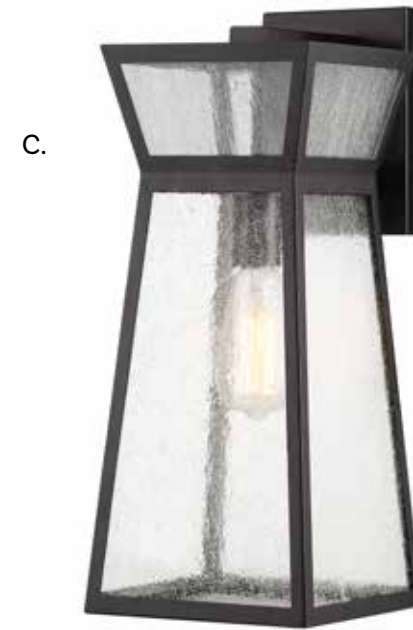

A. 5-638-BK
3-Light Outdoor
Hanging Lantern
Matte Black Finish
9"W x 23-1/4"H
3C 40W
Clear Seeded Glass

B. 5-633-BK
3-Light Outdoor
Post Lantern
Matte Black Finish
9"W x 23-1/4"H
3C 60W
Clear Seeded Glass

C. 5-635-BK
1-Light Outdoor
Wall Lantern
Matte Black Finish
7-1/2"W x 18-3/4"H x 9"E
1E 60W
Clear Seeded Glass

D. 5-637-BK
4-Light Outdoor
Wall Lantern
Matte Black Finish
11"W x 26-3/4"H x 12-1/4"E
4C 40W
Clear Seeded Glass

E. 5-636-BK
3-Light Outdoor
Wall Lantern
Matte Black Finish
9"W x 22"H x 10-1/2"E
3C 40W
Clear Seeded Glass

F. 5-634-BK
1-Light Outdoor
Wall Lantern
Matte Black Finish
5-1/2"W x 14"H x 7"E
1E 60W
Clear Seeded Glass

*Includes 120" chain & wire

OUTDOOR



*A.



B.



C.



D.



E.



F.

- A. 5-2025-BK**
1-Light Outdoor
Hanging Lantern
Matte Black Finish
8"W x 16-1/8"H
1E 60W
Clear Seeded Glass
- B. 5-2024-BK**
1-Light Outdoor
Post Lantern
Matte Black Finish
10"W x 19"H
1E 60W
Clear Seeded Glass
- C. 5-2020-BK**
1-Light Outdoor
Wall Lantern
Matte Black Finish
6"W x 11"H x 7-1/2"E
1E 60W
Clear Seeded Glass
- D. 5-2022-BK**
1-Light Outdoor
Wall Lantern
Matte Black Finish
10"W x 18"H x 11"E
1E 60W
Clear Seeded Glass
- E. 5-2023-BK**
3-Light Outdoor
Wall Lantern
Matte Black Finish
16"W x 29"H x 17"E
3C 60W
Clear Seeded Glass
- F. 5-2021-BK**
1-Light Outdoor
Wall Lantern
Matte Black Finish
8"W x 15"H x 9-1/2"E
1E 60W
Clear Seeded Glass

OUTDOOR

*Includes 120" chain & wire

WOODSTOCK

OUTDOOR



- A. 5-105-BK**
3-Light Outdoor
Semi-Flush
Matte Black Finish
12"W x 14-1/2"H
3C 60W
Clear Seeded Glass
Metal Candle Covers
- B. 5-101-BK**
3-Light Outdoor
Wall Lantern
Matte Black Finish
12"W x 23-1/2"H x 14"E
3C 60W
Clear Seeded Glass
Metal Candle Covers
- C. 5-100-BK**
1-Light Outdoor
Wall Lantern
Matte Black Finish
8"W x 16.5"H x 9"E
1E 60W
Clear Seeded Glass
- D. 5-102-BK**
4-Light Outdoor
Wall Lantern
Matte Black Finish
15"W x 30-1/2"H x 17"E
4C 60W
Clear Seeded Glass
Metal Candle Covers
- E. 5-104-BK**
4-Light Outdoor
Hanging Lantern
Matte Black Finish
15"W x 23-1/2"H
4C 60W
Clear Seeded Glass
Metal Candle Covers

WOODSTOCK

OUTDOOR



*Includes 120" chain & wire

OUTDOOR



OUTDOOR

- A. 5-723-153**
4-Light Outdoor Hanging Lantern
Black w/ Gold Highlights
14"W x 29-1/4"H
4C 40W
Clear Glass
Metal Candle Covers
- B. 5-724-153**
1-Light Outdoor Post Lantern
Black w/ Gold Highlights
9"W x 22-3/4"H
1E 60W
Clear Glass
- C. 5-722-153**
3-Light Outdoor Wall Lantern
Black w/ Gold Highlights
10-7/8"W x 25-1/2"H x 11-3/4"E
3C 40W
Clear Glass
Metal Candle Covers
- D. 5-721-153**
1-Light Outdoor Wall Lantern
Black w/ Gold Highlights
9"W x 22-3/8"H x 9-7/8"E
1E 60W
Clear Glass
- E. 5-720-153**
1-Light Outdoor Wall Lantern
Black w/ Gold Highlights
7"W x 17-1/2"H x 7-13/16"E
1E 60W
Clear Glass



*Includes 120" chain & wire

OUTDOOR

OUTDOOR



*A.



*B.



*E.



C.



D.



G.



F.

A. 5-145-BK
4-Light Outdoor
Hanging Lantern
Matte Black Finish
12"W x 21"H
4C 40W
Clear Glass
Metal Candle Covers

B. 5-148-BK
4-Light Outdoor
Hanging Lantern
Matte Black Finish
14"W x 25"H
4C 40W
Clear Glass
Metal Candle Covers

C. 5-141-BK
3-Light Outdoor
Wall Lantern
Matte Black Finish
9"W x 19"H x 11-1/4"E
3C 40W
Clear Glass
Metal Candle Covers

D. 5-147-BK
3-Light Outdoor
Post Lantern
Matte Black Finish
9"W x 17-1/2"H
3C 60W
Clear Glass
Metal Candle Covers

E. 5-146-BK
3-Light Outdoor
Hanging Lantern
Matte Black Finish
9"W x 15-3/4"H
3C 40W
Clear Glass
Metal Candle Covers

F. 5-142-BK
4-Light Outdoor
Wall Lantern
Matte Black Finish
12"W x 25-1/4"H x 15"E
4C 40W
Clear Glass
Metal Candle Covers

G. 5-140-BK
1-Light Outdoor
Wall Lantern
Matte Black Finish
6"W x 9-1/2"H x 7"E
1E 60W
Clear Glass

*Includes 120" chain & wire

*A.



*D.



E.



B.



C.



F.



A. 5-148-13
4-Light Outdoor
Hanging Lantern
English Bronze Finish
14"W x 25"H
4C 40W
Clear Glass
Metal Candle Covers

B. 5-141-13
3-Light Outdoor
Wall Lantern
English Bronze Finish
9"W x 19"H x 11-1/4"E
3C 40W
Clear Glass
Metal Candle Covers

C. 5-147-13
3-Light Outdoor
Post Lantern
English Bronze Finish
9"W x 17-1/2"H
3C 60W
Clear Glass
Metal Candle Covers

D. 5-146-13
3-Light Outdoor
Hanging Lantern
English Bronze Finish
9"W x 15-3/4"H
3C 40W
Clear Glass
Metal Candle Covers

E. 5-142-13
4-Light Outdoor
Wall Lantern
English Bronze Finish
12"W x 25-1/4"H x 15"E
4C 40W
Clear Glass
Metal Candle Cover

F. 5-140-13
1-Light Outdoor
Wall Lantern
English Bronze Finish
6"W x 9-1/2"H x 7"E
1E 60W
Clear Glass

*Includes 120" chain & wire

OUTDOOR



OUTDOOR

- A. 5-453-BK**
3-Light Outdoor Hanging Lantern
Matte Black Finish
10-1/2"W x 25"H
3C 40W
Clear Seeded Glass
Metal Candle Covers
- B. 5-450-BK**
1-Light Outdoor Wall Lantern
Matte Black Finish
6-3/4"W x 17-1/4"H x 7-1/2"E
1E 60W
Clear Seeded Glass
- C. 5-452-BK**
3-Light Outdoor Wall Lantern
Matte Black Finish
10-1/2"W x 27-3/4"H x 10-1/2"E
3C 40W
Clear Seeded Glass
Metal Candle Covers
- D. 5-451-BK**
1-Light Outdoor Wall Lantern
Matte Black Finish
8-1/2"W x 22-3/4"H x 9-1/4"E
1E 60W
Clear Seeded Glass
- E. 5-454-BK**
1-Light Outdoor Post Lantern
Matte Black Finish
8-1/2"W x 24-1/4"H
1E 60W
Clear Seeded Glass



*Includes 120" chain & wire

OUTDOOR



OUTDOOR

- A. 5-3455-BK**
1-Light Outdoor Hanging Lantern
Matte Black Finish
8"W x 18-3/4"H
1E 75W
Seeded Glass
- B. 5-3451-BK**
1-Light Outdoor Wall Lantern
Matte Black Finish
6-1/2"W x 16"H x 8"E
1E 60W
Seeded Glass
- C. 5-3453-BK**
3-Light Outdoor Wall Lantern
Matte Black Finish
11"W x 23-1/2"H x 13"E
3C 40W
Seeded Glass
- D. 5-3454-BK**
1-Light Outdoor Post Lantern
Matte Black Finish
8"W x 23-1/2"H
1E 60W
Seeded Glass
- E. 5-3452-BK**
1-Light Outdoor Wall Lantern
Matte Black Finish
8"W x 18"H x 9-1/2"E
1E 60W
Seeded Glass



*Includes 120" chain & wire

MONTE GRANDE

MONTE GRANDE

OUTDOOR

- A. 5-256-13**
3-Light Outdoor
Hanging Lantern
English Bronze Finish
10"W x 22-1/2"H
3C 40W
Pale Cream Seeded Glass
Cream Candle Covers
- B. 5-257-13**
4-Light Outdoor
Wall Lantern
English Bronze Finish
13"W x 34-1/2"H x 15-3/4"E
4C 40W
Pale Cream Seeded Glass
Cream Candle Covers
- C. 5-258-13**
1-Light Outdoor
Wall Lantern
English Bronze Finish
7"W x 17-3/4"H x 8-1/4"E
1E 60W
Pale Cream Seeded Glass
- D. 5-254-13**
1-Light Outdoor
Wall Lantern
English Bronze Finish
5-1/2"W x 11-1/2"H x 6-1/2"E
1E 60W
Pale Cream Seeded Glass
- E. 5-259-13**
3-Light Outdoor
Wall Lantern
English Bronze Finish
10"W x 26-3/4"H x 12"E
3C 40W
Pale Cream Seeded Glass
Cream Candle Covers
- F. 5-255-13**
3-Light Outdoor
Post Lantern
English Bronze Finish
10"W x 23-3/4"H
3C 60W
Pale Cream Seeded Glass
Cream Candle Cover



*Includes 120" chain & wire

OUTDOOR



- G. 5-256-25**
3-Light Outdoor
Hanging Lantern
Slate Finish
10"W x 22-1/2"H
3C 40W
Pale Cream Seeded Glass
Cream Candle Covers
- H. 5-257-25**
4-Light Outdoor
Wall Lantern
Slate Finish
13"W x 34-1/2"H x 15-3/4"E
4C 40W
Pale Cream Seeded Glass
Cream Candle Covers
- I. 5-258-25**
1-Light Outdoor
Wall Lantern
Slate Finish
7"W x 17-3/4"H x 8-1/4"E
1E 60W
Pale Cream Seeded Glass
- J. 5-254-25**
1-Light Outdoor
Wall Lantern
Slate Finish
5-1/2"W x 11-1/2"H x 6-1/2"E
1E 60W
Pale Cream Seeded Glass
- K. 5-255-25**
3-Light Outdoor
Post Lantern
Slate Finish
10"W x 23-3/4"H
3C 60W
Pale Cream Seeded Glass
Cream Candle Cover
- L. 5-259-25**
3-Light Outdoor
Wall Lantern
Slate Finish
10"W x 26-3/4"H x 12"E
3C 40W
Pale Cream Seeded Glass
Cream Candle Covers

OUTDOOR



A. 5-548-13
2-Light Outdoor Lantern
English Bronze Finish
9-1/2"W x 19-1/2"H x 11-1/2"E
2C 40W
Clear Glass

B. 5-549-13
4-Light Outdoor
Hanging Lantern
English Bronze Finish
12"W x 22"H
4C 60W
Clear Glass
Metal Candle Covers

C. 5-546-13
1-Light Outdoor Lantern
English Bronze Finish
6-1/2"W x 12-3/4"H x 8"E
1E 60W
Clear Glass

D. 5-547-13
1-Light Outdoor Sconce
English Bronze Finish
8"W x 16-1/2"H x 9-1/2"E
1E 60W
Clear Glass

OUTDOOR



A.



*B.



C.



D.

*Includes 120" chain & wire

OUTDOOR



OUTDOOR

*A.



A. 5-504-13
1-Light Outdoor
Hanging Lantern
English Bronze Finish
6-1/2"W x 17-1/4"H
1E 60W
Clear Glass

B. 5-505-13
1-Light Outdoor
Post Lantern
English Bronze Finish
6-1/2"W x 19-3/4"H
1E 60W
Clear Glass

C. 5-501-13
1-Light Outdoor
Wall Lantern
English Bronze Finish
6-1/2"W x 19-1/4"H x 7-3/4"E
1E 60W
Clear Glass

D. 5-502-13
1-Light Outdoor
Wall Lantern
English Bronze Finish
7-1/2"W x 24-1/2"H x 9"E
1E 60W
Clear Glass

E. 5-500-13
1-Light Outdoor
Wall Lantern
English Bronze Finish
5"W x 14-1/4"H x 6-1/4"E
1E 60W
Clear Glass

B.



C.



D.



E.



*Includes 120" chain & wire

OUTDOOR



OUTDOOR

A.



B.



**A. BROOKE
5-5910-BK**
1-Light Outdoor Wall
Lantern
Matte Black Finish
7-1/4"W x 17"H x 4-1/2"E
1C 60W
Clear Glass
Metal Candle Covers

**B. BROOKE
5-5911-BK**
2-Light Outdoor Wall
Lantern
Matte Black Finish
8-1/4"W x 20"H x 5"E
2C 60W
Clear Glass
Metal Candle Covers

ERICSON

OUTDOOR



A.



B.

- A. 5-1990-BK**
1-Light Outdoor Wall Lantern
Matte Black Finish
6"W x 18-1/2"H x 9-1/4"E
1E 60W
Clear Glass
- B. 5-1989-BK**
1-Light Outdoor Wall Lantern
Matte Black Finish
5.5"W x 16"H x 8-1/4"E
1E 60W
Clear Glass

HAMILTON

OUTDOOR



C.



D.

- C. 5-1986-BK**
1-Light Outdoor Wall Lantern
Matte Black Finish
7-1/2"W x 23-1/2"H x 9-1/2"E
1C 60W
Clear Outer Glass
White Opal Chimney
- D. 5-1985-BK**
1-Light Outdoor Wall Lantern
Matte Black Finish
6-1/2"W x 21"H x 8"E
1C 60W
Clear Outer Glass
White Opal Chimney

OUTDOOR



OUTDOOR

A. 5-342-213
1-Light Outdoor
Hanging Lantern
English Bronze w/
Gold Highlights
6-3/4"W x 15-3/4"H
1E 60W
Clear Seeded Glass

B. 5-340-213
1-Light Outdoor
Wall Lantern
English Bronze w/
Gold Highlights
5"W x 11-1/4"H x 5-7/8"E
1E 60W
Clear Seeded Glass

C. 5-341-213
1-Light Outdoor
Wall Lantern
English Bronze w/
Gold Highlights
6-1/2"W x 14-7/8"H x 7-3/8"E
1E 60W
Clear Seeded Glass

D. 5-344-213
1-Light Outdoor
Wall Lantern
English Bronze w/
Gold Highlights
8"W x 17-3/4"H x 9"E
1E 60W
Clear Seeded Glass

*A.



B.



C.



D.



*Includes 120" chain & wire



A.

B.

C.

A. 5-2066-51
 1-Light Outdoor Sconce
 Vintage Black w/
 Warm Brass Accents
 5"W x 13-1/2"H x 7"E
 1E 60W
 Clear Glass

B. 5-2067-51
 1-Light Outdoor Sconce
 Vintage Black w/
 Warm Brass Accents
 7-1/2"W x 20-3/4"H x 9-3/4"E
 1E 60W
 Clear Glass

C. 5-2068-51
 3-Light Outdoor Sconce
 Vintage Black w/
 Warm Brass Accents
 9-1/8"W x 23-1/2"H x 11-1/4"E
 3C 40W
 Clear Glass
 Metal Candle Covers

OUTDOOR

OUTDOOR



*A.



B.



C.



D.



E.

A. 5-1222-40
 3-Light Outdoor Hanging Lantern
 Walnut Patina Finish
 9"W x 25"H
 3C 40W
 Clear Seeded Glass
 Metal Candle Covers

B. 5-1223-40
 3-Light Outdoor Post Lantern
 Walnut Patina Finish
 9"W x 22"H
 3C 40W
 Clear Seeded Glass
 Metal Candle Covers

C. 5-1220-40
 2-Light Outdoor Wall Lantern
 Walnut Patina Finish
 7-1/2"W x 24"H x 11-3/4"E
 2C 40W
 Clear Seeded Glass
 Metal Candle Covers

D. 5-1221-40
 3-Light Outdoor Wall Lantern
 Walnut Patina Finish
 9"W x 26"H x 13"E
 3C 40W
 Clear Seeded Glass
 Metal Candle Covers

E. 5-1224-40
 4-Light Outdoor Wall Lantern
 Walnut Patina Finish
 11"W x 33-1/2"H x 16"E
 4C 40W
 Clear Seeded Glass
 Metal Candle Covers

*Includes 120" chain & wire

OUTDOOR



- | | | | | |
|--|---|--|---|---|
| A. 5-2953-185
1-Light Outdoor
Hanging Lantern
Lodge Finish
8-1/2"W x 19-3/4"H
1E 60W
Clear Seeded Glass | B. 5-2954-185
1-Light Outdoor
Post Lantern
Lodge Finish
8-1/2"W x 17-1/2"H
1E 60W
Clear Seeded Glass | C. 5-2952-185
1-Light Outdoor
Wall Lantern
Lodge Finish
8-1/2"W x 17-1/2"H x 10"E
1E 60W
Clear Seeded Glass | D. 5-2950-185
1-Light Outdoor
Wall Lantern
Lodge Finish
5-3/4"W x 11-3/4"H x 6-3/4"E
1E 60W
Clear Seeded Glass | E. 5-2951-185
1-Light Outdoor
Wall Lantern
Lodge Finish
7-1/2"W x 14-1/2"H x 8-1/2"E
1E 60W
Clear Seeded Glass |
|--|---|--|---|---|

OUTDOOR



*Includes 120" chain & wire

OUTDOOR



OUTDOOR

- A. 5-243-213**
1-Light Outdoor
Hanging Lantern
English Bronze
w/ Gold Highlights
7-3/4"W x 17"H
1E 60W
Clear Glass
- B. 5-241-213**
1-Light Outdoor
Wall Lantern
English Bronze
w/ Gold Highlights
7-3/4"W x 16"H x 8-3/8"E
1E 60W
Clear Glass
- C. 5-242-213**
2-Light Outdoor
Wall Lantern
English Bronze
w/ Gold Highlights
9-1/4"W x 19-1/4"H x
9-7/8"E
2C 40W
Clear Glass
- D. 5-244-213**
1-Light Outdoor
Post Lantern
English Bronze
w/ Gold Highlights
7-3/4"W x 18-3/8"H
1E 60W
Clear Glass
- E. 5-240-213**
1-Light Outdoor
Wall Lantern
English Bronze
w/ Gold Highlights
6-1/4"W x 13-3/4"H x 7"E
1E 60W
Clear Glass



*Includes 120" chain & wire

ENDURE ALL: Injection Molding = Durability, Weather Resistant, UV Resistant, Non-Corrosive



OUTDOOR



A. 5-300-BK
 3-Light Outdoor Wall Lantern
 Matte Black Finish
 10-1/8"W x 28"H x 13-1/2"E
 3C 40W
 Clear Water Glass
 Metal Candle Covers

B. 5-305-BK
 2-Light Outdoor Wall Lantern
 Matte Black Finish
 7-7/8"W x 22"H x 11-1/4"E
 2C 40W
 Clear Water Glass
 Metal Candle Covers

C. 5-304-BK
 2-Light Outdoor Wall Lantern
 Matte Black Finish
 7-7/8"W x 17-7/8"H x 9-3/4"E
 2C 40W
 Clear Water Glass
 Metal Candle Covers

OUTDOOR





A.



B.



C.

A. 5-300-40
 3-Light Outdoor Wall Lantern
 Walnut Patina Finish
 10-1/8"W x 28"H x 13-1/2"E
 3C 40W
 Clear Water Glass
 Metal Candle Covers

B. 5-305-40
 2-Light Outdoor Wall Lantern
 Walnut Patina Finish
 7-7/8"W x 22"H x 11-1/4"E
 2C 40W
 Clear Water Glass
 Metal Candle Covers

C. 5-304-40
 2-Light Outdoor Wall Lantern
 Walnut Patina Finish
 7-7/8"W x 17-7/8"H x 9-3/4"E
 2C 40W
 Clear Water Glass
 Metal Candle Covers

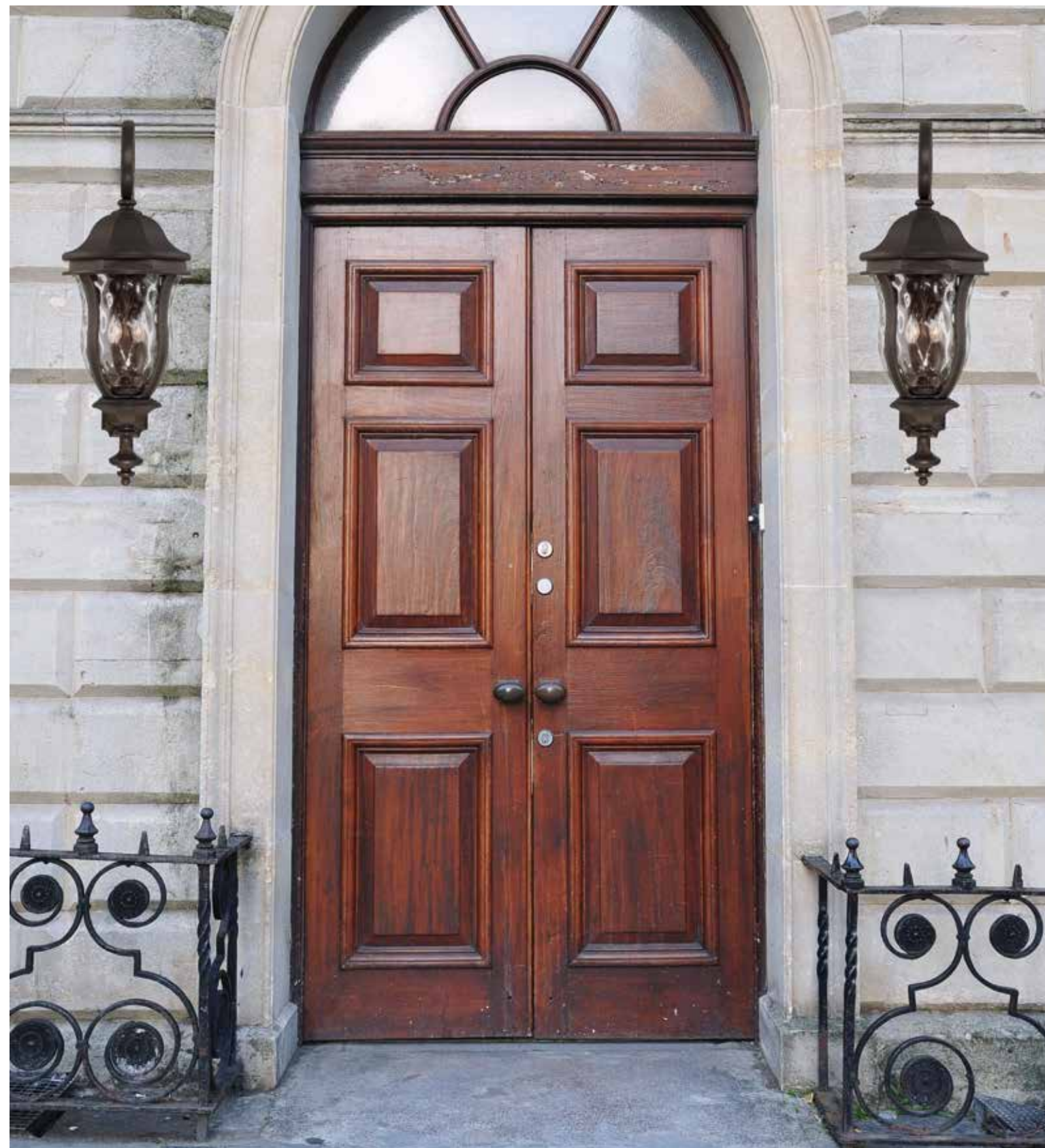

WALL LIGHTING

OUTDOOR



A.

A. BELMONT
5-179-137
 1-Light Outdoor
 Wall Lantern
 Textured Black w/ Warm
 Brass Accents
 12"W x 13"H x 13"E
 1E 60W

WALL LIGHTING

OUTDOOR



B.



C.



D.



E.



F.



G.

B. RALEIGH
5-9584-BK
 1-Light Outdoor
 Wall Lantern
 Matte Black Finish
 11"W x 11"H x 15-1/2"E
 1E 60W

C. DANSK
9-6074-1-90
 1-Light Sconce
 Galvanized Metal Finish
 8"W x 13"H x 10"E
 1E 60W
UL Damp Rated

D. MICA
5-5030-1-32
 1-Light Outdoor
 Wall Lantern
 Artisan Rust Finish
 9"W x 10"H x 10-1/2"E
 1E 60W
 Clear Seeded Glass

E. MICA
5-5031-1-32
 1-Light Outdoor
 Wall Lantern
 Artisan Rust Finish
 11"W x 11"H x 12-1/2"E
 1E 60W
 Clear Seeded Glass

F. DUNSTON DS
5-5630-DS-13
 1-Light Outdoor
 Dark Sky Wall Lantern
 English Bronze Finish
 8"W x 7-1/2"H x 9-1/4"E
 1E 60W

G. DUNSTON DS
5-5631-DS-13
 1-Light Outdoor
 Dark Sky Wall Lantern
 English Bronze Finish
 11"W x 9-1/2"H x 11-1/2"E
 1E 60W

OUTDOOR



A.



*B.



C.



D.



*E.



F.

- A. 5-0630-BK**
1-Light Outdoor Wall Lantern
Textured Black Finish
8-1/4"W x 20"H x 7-3/4"E
1E 60W
Clear Beveled Glass
- B. 5-0635-BK**
3-Light Outdoor Hanging Lantern
Textured Black Finish
8-1/4"W x 13-3/4"H
3C 40W
Clear Beveled Glass
Metal Candle Covers
- C. 5-0629-BK**
1-Light Outdoor Wall Lantern
Textured Black Finish
5-1/2"W x 10-1/2"H x 6"E
1E 60W
Clear Beveled Glass
- D. 5-0634-BK**
1-Light Outdoor Wall Lantern
Textured Black Finish
7-3/4"W x 11-1/2"H x 8"E
1E 60W
Clear Beveled Glass
- E. 5-0631-BK**
1-Light Outdoor Hanging Lantern
Textured Black Finish
8-1/8"W x 17-3/4"H
1E 60W
Clear Beveled Glass
- F. 5-0633-BK**
1-Light Outdoor Wall Lantern
Textured Black Finish
8-1/4"W x 15-3/4"H x 7-3/4"E
1E 60W
Clear Beveled Glass

*Includes 120" chain & wire



G.



H.



I.



J.



K.



L.



M.

- G. SCOUT 6-8074-15-SN**
15" Flush Mount
Satin Nickel Finish
15"W x 6-1/2"H
3E 60W
- H. SCOUT 6-8074-15-13**
15" Flush Mount
English Bronze Finish
15"W x 6-1/2"H
3E 60W
- I. BARRETT 5-369-13-13**
13" Flush Mount
English Bronze Finish
13"W x 6-3/4"H
2E 60W
Clear Seeded Glass
- J. BARRETT 5-369-13-BK**
13" Flush Mount
Matte Black Finish
13"W x 6-3/4"H
2E 60W
Clear Seeded Glass
- K. BARRETT 5-369-10-13**
10" Flush Mount
English Bronze Finish
10"W x 6"H
1E 60W
Clear Seeded Glass
- L. BARRETT 5-369-10-BK**
10" Flush Mount
Matte Black Finish
10"W x 6"H
1E 60W
Clear Seeded Glass
- M. 5-2066-72**
9" Flush Mount
Rustic Bronze Finish
9"W x 5"H
1E 60W
Frosted Glass

OUTDOOR

EXTERIOR COLLECTIONS

OUTDOOR



A. 5-1161-RP
1-Light Outdoor
Wall Lantern
Rust Finish
4-3/4"W x 7-7/8"H x
5-1/2"E
1E 60W
Clear Glass

B. 5-1161-BK
1-Light Outdoor
Wall Lantern
Matte Black Finish
4-3/4"W x 7-7/8"H x
5-1/2"E
1E 60W
Clear Glass

C. 5-3045-72
1-Light Outdoor
Wall Lantern
Rustic Bronze Finish
6"W x 9"H x 7"E
1E 60W
Clear Glass

D. 5-3045-BK
1-Light Outdoor
Wall Lantern
Matte Black Finish
6"W x 9"H x 7"E
1E 60W
Clear Glass

EXTERIOR COLLECTIONS

OUTDOOR





































































STEM INFORMATION

ITEM	FAMILY	EXT or EXTLG	SWIVEL	LENGTHS OF STEM / #STEMS IN BOX
1-1099-5-182	LARAMIE	EXT	30°	12" (4pcs) & 6" (1pc)
1-1099-5-183	LARAMIE	EXT	30°	12" (4pcs) & 6" (1pc)
1-1270-6-50	AZORES	EXTLG	30°	12" (8pcs) & 6" (2pcs)
1-1590-9-38	AMANI	EXTLG	30°	12" (8pcs) & 6" (2pcs)
1-1590-9-50	AMANI	EXTLG	30°	12" (8pcs) & 6" (2pcs)
1-1591-14-38	AMANI	EXTLG	30°	12" (8pcs) & 6" (2pcs)
1-1591-14-50	AMANI	EXTLG	30°	12" (8pcs) & 6" (2pcs)
1-1635-5-143	ASHOR	EXT	30°	12" (4pcs) & 6" (1pc)
1-1636-8-143	ASHOR	EXT	-	12" (4pcs) & 6" (1pc)
1-1637-8-143	ASHOR	EXTLG	30°	12" (4pcs) & 6" (1pc)
1-1715-8-154	CHAUCER	EXT	30°	12" (4pcs) & 6" (1pc)
1-1716-8-322	CHAUCER	EXT	30°	12" (4pcs) & 6" (1pc)
1-1732-10-322	ARLON	EXT	30°	12" (8pcs) & 6" (2pcs)
1-1733-12-322	ARLON	EXT	30°	12" (8pcs) & 6" (2pcs)
1-1734-24-322	ARLON	EXT	30°	12" (8pcs) & 6" (2pcs)
1-1738-5-320	ASHE	EXTLG	30°	12" (8pcs) & 6" (2pcs)
1-1760-8-198	DANIELS	EXTLG	30°	12" (4pcs) & 6" (1pc)
1-1760-8-80	DANIELS	EXTLG	30°	12" (4pcs) & 6" (1pc)
1-1770-5-200	ASTORIA	EXT	30°	12" (8pcs) & 6" (2pcs)
1-1790-36-89	HAVEN	EXT	30°	12" (8pcs) & 6" (2pcs)
1-1800-16-171	VISTA	EXTLG	30°	12" (8pcs) & 6" (2pcs)
1-1800-16-89	VISTA	EXTLG	30°	12" (8pcs) & 6" (2pcs)
1-1805-10-109	KAMERON	EXTLG	30°	12" (4pcs) & 6" (1pc)
1-1805-10-322	KAMERON	EXTLG	30°	12" (4pcs) & 6" (1pc)
1-1805-10-89	KAMERON	EXTLG	30°	12" (4pcs) & 6" (1pc)
1-181-4-171	BEACON	EXT	30°	12" (4pcs) & 6" (1pc)
1-1813-5-143	ECLIPSE	EXTLG	30°	12" (8pcs) & 6" (2pcs)
1-1824-6-320	CANNON	EXT	30°	12" (4pcs) & 6" (1pc)
1-1846-4-127	LIVORNO	EXT	30°	12" (4pcs) & 6" (1pc)
1-1847-8-127	LIVORNO	EXT	30°	12" (4pcs) & 6" (1pc)
1-1857-6-62	ARIEL	EXT	30°	12" (4pcs) & 6" (1pc)
1-1858-6-62	ARIEL	EXTLG	30°	12" (4pcs) & 6" (1pc)
1-187-3-143	DELPHI	EXT	30°	12" (8pcs) & 6" (2pcs)
1-187-3-172	DELPHI	EXT	30°	12" (8pcs) & 6" (2pcs)
1-1887-6-143	TIVOLI	EXT	30°	12" (4pcs) & 6" (1pc)
1-1889-8-143	TIVOLI	EXT	30°	12" (8pcs) & 6" (2pcs)
1-1893-6-143	TIVOLI	EXT	30°	12" (4pcs) & 6" (1pc)
1-1906-6-143	MIDLAND	EXT	30°	12" (4pcs) & 6" (1pc)
1-1907-8-143	MIDLAND	EXT	30°	12" (8pcs) & 6" (2pcs)
1-191-6-143	EDINA	EXT	30°	12" (4pcs) & 6" (1pc)
1-1975-5-143	EATON	EXT	30°	12" (4pcs) & 6" (1pc)
1-1976-6-143	EATON	EXT	30°	12" (4pcs) & 6" (1pc)
1-1982-4-143	EATON	EXT	30°	12" (8pcs) & 6" (2pcs)

















































STEM INFORMATION

ITEM	FAMILY	EXT or EXTLG	SWIVEL	LENGTHS OF STEM / #STEMS IN BOX
1-2031-5-260	PORTIA	EXTLG	30°	12" (4pcs) & 6" (1pc)
1-2032-6-260	PORTIA	EXT	30°	12" (8pcs) & 6" (2pcs)
1-2106-5-322	SHELLBOURNE	EXT	30°	12" (4pcs) & 6" (1pc)
1-2135-5-67	FOLSOM	EXT	30°	12" (8pcs) & 6" (2pcs)
1-2139-8-67	FOLSOM	EXT	30°	12" (8pcs) & 6" (2pcs)
1-2200-8-322	BURNHAM	EXT	30°	12" (4pcs) & 6" (1pc)
1-2202-6-322	BURNHAM	EXT	30°	12" (4pcs) & 6" (1pc)
1-2304-6-260	QUATRIN	EXT	30°	12" (4pcs) & 6" (1pc)
1-2305-8-260	QUATRIN	EXT	30°	12" (8pcs) & 6" (2pcs)
1-2330-5-60	ORLEANS	EXTLG	30°	12" (8pcs) & 6" (2pcs)
1-3165-8-322	GIDEON	EXT	30°	12" (8pcs) & 6" (2pcs)
1-3166-6-322	GIDEON	EXTLG	30°	12" (4pcs) & 6" (1pc)
1-3167-4-322	GIDEON	EXT	30°	12" (4pcs) & 6" (1pc)
1-3720-6-89	BOCA	EXTLG	30°	12" (4pcs) & 6" (1pc)
1-3722-10-89	BOCA	EXTLG	30°	12" (4pcs) & 6" (1pc)
1-4418-3-322	ADAMS	EXT	30°	12" (4pcs) & 6" (1pc)
1-4419-5-322	ADAMS	EXT	30°	12" (4pcs) & 6" (1pc)
1-5404-8-79	CAPELLA	EXT	30°	12" (8pcs) & 6" (2pcs)
1-5500-6-322	NOUVEL	EXT	30°	12" (4pcs) & 6" (1pc)
1-5502-8-322	NOUVEL	EXT	30°	12" (4pcs) & 6" (1pc)
1-5533-8-143	ARCHWAY	EXT	30°	12" (8pcs) & 6" (2pcs)
1-6400-8-190	SALEM	EXT	30°	12" (1pc)
1-6402-16-190	SALEM	EXT	30°	14.5" (1pc)
1-6620-6-89	KAHN	EXTLG	30°	12" (4pcs) & 6" (1pc)
1-6622-9-89	KAHN	EXTLG	30°	12" (4pcs) & 6" (1pc)
1-6697-4-143	COUPLET	EXT	30°	12" (4pcs) & 6" (1pc)
1-6698-8-143	COUPLET	EXT	30°	12" (4pcs) & 6" (1pc)
1-6699-8-143	COUPLET	EXT	30°	12" (8pcs) & 6" (2pcs)
1-7750-4-322	WYNWOOD	EXT	30°	12" (4pcs) & 6" (1pc)
1-7751-5-322	WYNWOOD	EXT	30°	12" (4pcs) & 6" (1pc)
1-7752-6-322	WYNWOOD	EXTLG	30°	12" (4pcs) & 6" (1pc)
1-8042-6-79	KIRKLAND	EXTLG	30°	12" (4pcs) & 6" (1pc)
1-8070-8-51	KEARNEY	EXT	30°	12" (4pcs) & 6" (1pc)
1-8072-4-51	KEARNEY	EXT	30°	12" (4pcs) & 6" (1pc)
1-8803-5-322	HELEN	EXT	30°	12" (4pcs) & 6" (1pc)
1-8804-8-322	HELEN	EXTLG	30°	12" (4pcs) & 6" (1pc)
1-8892-5-101	HASTING	EXT	30°	12" (8pcs) & 6" (2pcs)
1-9704-10-322	BENNINGTON	EXTLG	30°	12" (4pcs) & 6" (1pc)
1-9705-16-322	BENNINGTON	EXTLG	30°	12" (4pcs) & 6" (1pc)
1-9945-5-143	QUINCY	EXT	30°	12" (4pcs) & 6" (1pc)
3-1772-6-200	ASTORIA	EXT	30°	12" (4pcs) & 6" (1pc)
3-1773-6-320	ASHBURN	EXTLG	30°	12" (4pcs) & 6" (1pc)
3-1791-22-89	HAVEN	EXT	30°	12" (4pcs) & 6" (1pc)

FINISH GUIDE

	02 Oiled Bronze		62 Como Black w/ Gold		95 Warm Brass w/ Bronze Accents
	11 Polished Chrome		63 Warm Brass Lustre		96 Barrelwood w/ Brass Accents
	13 English Bronze		66 Matte Black w/ Satin Nickel		99 Provence
	21 Burnished Russet		67 Matte Black w/ Polished Chrome Accents		100 Aurora
	23 White Washed Driftwood		68 Whiskey Wood		101 Noblewood w/ Iron
	25 Slate		69 Pewter		109 Polished Nickel
	28 Oiled Burnished Bronze		70 Weathervane		110 Polished Chrome w/ Wooden Beads
	32 Artisan Rust		72 Rustic Bronze		111 Satin Nickel w/ Polished Nickel Accents
	36 Natural Walnut w/ Black Accents		76 Florencian Bronze		114 Britannia Gold
	38 Royal Gold		77 Bronze w/ Brass Accents		121 Mohican Bronze
	39 Fossil Stone		79 English Bronze & Warm Brass		124 Fiesta Bronze
	40 Walnut Patina		80 Matte White		127 Noble Brass
	41 Durango		81 Distressed White		128 Café
	44 Classic Bronze		82 Porcellana		129 Espresso
	45 Aged Wood		83 Bisque White		130 Aged Pewter
	46 Calypso		84 Rubbed Bronze W/ Gold Leaf		133 Sapele Finish
	47 White Cashmere		85 Rubbed Zinc w/ Silver Leaf		137 Textured Black w/ Warm Brass Accents
	50 Black Cashmere		88 Oxidized Black		139 Greywood w/ Pewter
	51 Vintage Black w/ Warm Brass Accents		89 Matte Black		142 White w/ Warm Brass Accents
	53 Silver Patina		90 Galvanized Metal		143 Black w/ Warm Brass Accents
	54 Gold Patina		92 Rumba		144 Matte Black w/ Burnished Brass Accents
	57 Polished Pewter		94 Avignon		
	60 Distressed Gold				

FINISH GUIDE

	150 Kenyon Black & Chrome		180 Matte Black w/ Dark Rattan		320 Warm Brass & Rope
	153 Black w/ Gold Highlights		181 Gunsmoke w/ Gray Rattan		322 Warm Brass
	154 Antique Nickel		182 Chelsea Gold		323 Old Bronze
	155 Provence w/ Gold Accents		183 Chelsea Walnut		BK Black
	160 White w/ Brass Accents		184 Grapevine		BZ Bronze
	161 Navy Blue w/ Warm Brass Accents		185 Lodge Finish		CH Chrome
	162 Aged Driftwood		187 Brushed Pewter		SN Satin Nickel
	165 Satin Nickel w/ Gray Wood		190 Forged Iron		WH White
	166 Black w/ Greywood		191 Darkwood w/ Black Accents		
	168 Galvanized Aluminum		193 Sweetgum		
	170 Burnished Brass w/ Walnut		194 Mesquite		
	171 Burnished Brass		195 Warm Brass w/ Chrome Accents		
	172 White w/ Polished Nickel Accents		196 Reclaimed Wood		
	173 Black w/ Polished Nickel Accents		198 Natural Antler		
	174 Navy w/ Polished Nickel Accents		211 Argentum		
	175 Gray w/ Polished Nickel Accents		212 Argentum & Gold		
	177 Burnished Brass w/ Natural Rattan		213 English Bronze w/ Gold		
	178 Aspen		242 Aged Steel		
	179 Mottled Zinc w/ Natural Rattan		260 True Gold		
			261 Matte Black w/ True Gold		
			272 Silver Dust		
			307 Silver Sparkle		

Savoy House mini-pendants are supplied with three 9-1/2" extension rods.

INDEX

1-1099-5-182.....	181	1-1852-10-89.....	47	1-4072-5-13.....	237
1-1099-5-183.....	181	1-1857-6-62.....	165	1-4418-3-322.....	40
1-1130-8-13.....	320	1-1858-6-62.....	165	1-4419-5-322.....	40
1-1270-6-50.....	81	1-1865-3-322.....	59	1-4486-12-89.....	88
1-1590-9-38.....	159	1-1866-4-322.....	59	1-4488-8-89.....	88, 255
1-1590-9-50.....	161	1-1867-10-322.....	59, 242	1-5404-8-79.....	113, 248
1-1591-14-38.....	159	1-187-3-143.....	121, 249	1-5500-6-322.....	17
1-1591-14-50.....	161	1-187-3-172.....	120, 249	1-5502-8-322.....	17
1-1635-5-143.....	104	1-1882-5-178.....	95	1-5533-8-143.....	168, 250
1-1636-8-143.....	104, 246	1-1883-8-178.....	95, 257	1-6400-8-190.....	179
1-1637-8-143.....	104	1-1887-6-143.....	110	1-6402-16-190.....	179
1-1641-4-143.....	106	1-1889-8-143.....	110, 244	1-6620-6-89.....	87
1-1642-10-143.....	106	1-1893-6-143.....	110	1-6622-9-89.....	87
1-1668-9-143.....	75	1-1906-6-143.....	114	1-6686-6-127.....	53
1-1669-4-143.....	75	1-1907-8-143.....	114, 244	1-6688-8-127.....	53
1-1672-12-322.....	213	1-191-6-143.....	77, 248	1-6697-4-143.....	166
1-1672-12-89.....	213	1-1932-15-322.....	210	1-6698-8-143.....	166
1-1675-8-171.....	205	1-1934-12-143.....	209	1-6699-8-143.....	166, 250
1-1675-8-89.....	205	1-1938-36-89.....	85, 207	1-7716-6-195.....	4
1-1709-8-13.....	50, 257	1-1939-12-89.....	85	1-7718-8-195.....	4
1-1715-8-154.....	189	1-1943-10-89.....	203	1-7750-4-322.....	38
1-1716-8-322.....	189	1-1946-10-260.....	63	1-7751-5-322.....	38
1-1727-5-322.....	26	1-1975-5-143.....	116	1-7752-6-322.....	38
1-1733-12-322.....	18	1-1976-6-143.....	116	1-801-5-02.....	182
1-1734-24-322.....	18	1-1982-4-143.....	116	1-803-3-02.....	182, 256
1-1738-5-320.....	145, 253	1-2031-5-260.....	71	1-8042-6-79.....	127
1-1760-8-198.....	135	1-2032-6-260.....	71, 246	1-8070-8-51.....	129
1-1760-8-80.....	135	1-2100-6-70.....	323	1-8702-8-322.....	61
1-1761-6-198.....	136	1-2106-5-322.....	11	1-8803-5-322.....	6
1-1761-6-80.....	136	1-2135-5-67.....	173	1-8804-8-322.....	6
1-1765-6-110.....	163	1-2139-8-67.....	173	1-8892-5-101.....	195, 255
1-1766-8-110.....	163	1-2200-8-322.....	57	1-9084-12-13.....	215
1-1770-5-200.....	146, 253	1-2202-6-322.....	57	1-9704-10-322.....	14
1-1790-36-89.....	170, 247	1-2206-8-322.....	33	1-9705-16-322.....	14
1-1800-16-171.....	200	1-2208-10-322.....	33	1-990-8-41.....	197, 256
1-1800-16-89.....	200	1-2304-6-260.....	36	1-991-8-41.....	197
1-1805-10-109.....	198	1-2305-8-260.....	36, 254	1-9945-5-143.....	34
1-1805-10-322.....	198	1-2330-5-60.....	13	1-9995-5-99.....	193
1-1805-10-89.....	198	1-3043-5-13.....	48	3-1772-6-200.....	146
1-181-4-171.....	156	1-3060-6-60.....	65	3-1773-6-320.....	143
1-1811-4-143.....	118	1-3165-8-322.....	20, 254	3-1791-22-89.....	170
1-1813-5-143.....	118, 245	1-3166-6-322.....	20	3-1923-4-261.....	124
1-1823-6-320.....	141	1-3167-4-322.....	23	3-3041-4-13.....	49
1-1824-6-320.....	141	1-3364-6-322.....	9	3-4080-4-79.....	239
1-1838-6-154.....	184	1-3720-6-89.....	83	3-4081-4-79.....	239
1-1838-6-322.....	184	1-3722-10-89.....	83	3-4390-5-47.....	175
1-1846-4-127.....	54	1-3804-6-142.....	43	3-4390-5-50.....	175
1-1847-8-127.....	54, 242	1-3804-6-143.....	43	3-4391-6-47.....	175

INDEX

3-4391-6-50.....	175	5-2067-51.....	365	5-369-10-BK.....	379
3-6821-4-13.....	239	5-2068-51.....	365	5-369-13-13.....	379
3-8072-4-51.....	129	5-240-213.....	370	5-369-13-BK.....	379
3-8811-6-92.....	177	5-241-213.....	370	5-450-BK.....	348
5-0629-BK.....	378	5-242-213.....	370	5-451-BK.....	348
5-0630-BK.....	378	5-243-213.....	370	5-452-BK.....	348
5-0631-BK.....	378	5-244-213.....	370	5-453-BK.....	348
5-0633-BK.....	378	5-254-13.....	352	5-454-BK.....	348
5-0634-BK.....	378	5-254-25.....	353	5-500-13.....	357
5-0635-BK.....	378	5-255-13.....	352	5-501-13.....	357
5-100-BK.....	340	5-255-25.....	353	5-502-13.....	357
5-101-BK.....	340	5-256-13.....	352	5-5030-1-32.....	377
5-102-BK.....	340	5-256-25.....	353	5-5031-1-32.....	377
5-104-BK.....	340	5-257-13.....	352	5-504-13.....	357
5-105-BK.....	340	5-257-25.....	353	5-505-13.....	357
5-1161-BK.....	380	5-258-13.....	352	5-546-13.....	354
5-1161-RP.....	380	5-258-25.....	353	5-547-13.....	354
5-1220-40.....	366	5-259-13.....	352	5-548-13.....	354
5-1221-40.....	367	5-259-25.....	353	5-549-13.....	354
5-1222-40.....	366	5-2950-185.....	368	5-5630-DS-13.....	377
5-1223-40.....	366	5-2951-185.....	368	5-5631-DS-13.....	377
5-1224-40.....	367	5-2952-185.....	368	5-5910-BK.....	359
5-140-13.....	347	5-2953-185.....	368	5-5911-BK.....	359
5-140-BK.....	345	5-2954-185.....	368	5-633-BK.....	337
5-141-13.....	346	5-300-40.....	374	5-634-BK.....	337
5-141-BK.....	344	5-300-BK.....	372	5-635-BK.....	337
5-142-13.....	347	5-304-40.....	374	5-636-BK.....	337
5-142-BK.....	345	5-304-BK.....	372	5-637-BK.....	337
5-145-BK.....	344	5-3045-72.....	380	5-638-BK.....	337
5-146-13.....	347	5-3045-BK.....	380	5-714-143.....	331
5-146-BK.....	345	5-305-40.....	374	5-715-143.....	331
5-147-13.....	346	5-305-BK.....	372	5-716-143.....	331
5-147-BK.....	344	5-340-213.....	362	5-717-143.....	331
5-148-13.....	346	5-341-213.....	362	5-718-143.....	331
5-148-BK.....	344	5-342-213.....	362	5-719-143.....	331
5-179-137.....	376	5-344-213.....	362	5-720-153.....	342
5-1985-BK.....	361	5-3451-BK.....	350	5-721-153.....	342
5-1986-BK.....	361	5-3452-BK.....	350	5-722-153.....	342
5-1989-BK.....	360	5-3453-BK.....	350	5-723-153.....	342
5-1990-BK.....	360	5-3454-BK.....	350	5-724-153.....	342
5-2020-BK.....	339	5-3455-BK.....	350	5-763-BK.....	329
5-2021-BK.....	339	5-352-BK.....	335	5-764-BK.....	329
5-2022-BK.....	339	5-353-BK.....	335	5-765-BK.....	329
5-2023-BK.....	339	5-354-BK.....	335	5-766-BK.....	329
5-2024-BK.....	339	5-355-BK.....	335	5-768-BK.....	329
5-2025-BK.....	339	5-356-BK.....	335	5-769-BK.....	329
5-2066-51.....	365	5-357-BK.....	335	5-812-BK.....	333
5-2066-72.....	379	5-369-10-13.....	379	5-813-BK.....	333

INDEX

5-814-BK.....	333	7-1812-4-143.....	118	7-488-6-53.....	231
5-815-BK.....	333	7-182-3-171.....	156	7-488-6-54.....	231
5-816-BK.....	333	7-1825-5-320.....	138	7-5014-3-84.....	225
5-817-BK.....	333	7-1836-4-154.....	187	7-5014-3-85.....	225
5-9584-BK.....	377	7-1836-4-322.....	187	7-5402-4-79.....	113
6-1272-4-50.....	79	7-1837-3-154.....	187	7-5532-4-143.....	168
6-1662-4-322.....	31	7-1837-3-322.....	187	7-7406-5-39.....	192
6-1682-5-320.....	145	7-1850-8-89.....	47	7-7772-6-180.....	150
6-1685-1-142.....	317	7-1851-12-89.....	47	7-804-1-02.....	182, 240
6-1685-1-143.....	317	7-1870-4-28.....	44	7-8041-5-79.....	127
6-1685-1-175.....	317	7-1870-4-322.....	44	7-8700-4-322.....	61
6-1695-4-143.....	101, 318	7-1871-4-28.....	44	7-8701-6-322.....	61
6-1822-4-143.....	106	7-1871-4-322.....	44	7-8810-6-92.....	177
6-1981-1-143.....	318	7-1872-3-28.....	191	7-885-1-182.....	226
6-3042-4-13.....	49, 319	7-1872-3-322.....	191	7-885-1-183.....	226
6-4602-1-142.....	218	7-1878-4-66.....	91	7-8850-5-142.....	232
6-4602-1-143.....	218	7-1879-6-66.....	91	7-8850-5-143.....	232
6-6684-4-127.....	53	7-188-6-143.....	121	7-886-3-182.....	226
6-8074-15-13.....	319, 379	7-188-6-172.....	120	7-886-3-183.....	226
6-8074-15-SN.....	319, 379	7-192-4-143.....	77	7-8882-1-172.....	223
6-9353-3-46.....	97	7-1920-3-261.....	123	7-8882-1-173.....	223
6-9985-3-94.....	318	7-1927-6-143.....	125	7-8882-1-174.....	223
7-100-3-53.....	229	7-1929-4-261.....	122	7-8882-1-175.....	223
7-100-3-54.....	229	7-1947-8-260.....	63	7-8890-1-194.....	241
7-101-6-53.....	229	7-1983-1-143.....	116	7-8891-3-194.....	241
7-101-6-54.....	229	7-2064-1-51.....	240	7-8893-4-101.....	195
7-1271-6-50.....	79	7-2241-3-67.....	172	7-9008-4-28.....	237
7-1610-6-322.....	73	7-2303-4-260.....	36	7-9009-5-28.....	237
7-1610-6-89.....	73	7-2331-4-60.....	13	7-9341-4-162.....	327
7-1620-43-322.....	69	7-2351-12-11.....	93	7-9350-6-46.....	97
7-1621-53-322.....	69	7-2416-3-143.....	221	7-9351-8-46.....	97
7-1639-6-144.....	109	7-2416-3-160.....	221	7-9352-10-46.....	99
7-1640-8-144.....	109	7-2416-3-161.....	221	7-9703-2-322.....	234
7-1643-1-143.....	106	7-2851-4-322.....	66	8-1255-2-165.....	313
7-1656-3-128.....	155	7-2852-6-322.....	66	8-1255-2-41.....	313
7-1657-3-89.....	155	7-3040-6-13.....	49	8-1255-3-165.....	313
7-1660-6-322.....	31	7-3168-3-322.....	23, 234	8-1255-3-41.....	313
7-1690-1-142.....	217	7-3362-6-322.....	9	8-1255-4-165.....	313
7-1690-1-143.....	217	7-3398-1-322.....	234	8-1255-4-41.....	313
7-1690-1-175.....	217	7-4199-6-171.....	131	8-1638-3-143.....	289
7-1696-5-143.....	101	7-4199-6-83.....	131	8-1638-4-143.....	289
7-1703-6-13.....	153	7-4366-4-322.....	29	8-1638-5-143.....	289
7-1708-5-13.....	50	7-4368-6-322.....	29	8-1648-2-BK.....	295
7-1732-10-322.....	18	7-4600-1-142.....	218	8-1648-3-BK.....	295
7-1739-4-320.....	145	7-4600-1-143.....	218	8-1648-4-BK.....	295
7-1771-6-200.....	146	7-4618-6-83.....	133	8-1720-2-143.....	285
7-1774-6-320.....	143	7-487-4-53.....	231	8-1720-3-143.....	285
7-1810-1-143.....	118	7-487-4-54.....	231	8-1720-4-143.....	285

INDEX

8-1724-2-143.....	298	8-560-4-11.....	306	9-195CP-1-322.....	265
8-1724-2-66.....	298	8-560-4-BK.....	306	9-195CP-1-89.....	265
8-1724-3-143.....	298	8-6080-2-143.....	293	9-1972-1-322.....	302
8-1724-3-66.....	298	8-6080-3-143.....	293	9-1977-1-143.....	274, 290
8-1724-4-143.....	298	8-6080-4-143.....	293	9-2030-2-260.....	272
8-1724-4-66.....	298	8-6601-2-11.....	301	9-2065-1-51.....	274
8-1780-2-111.....	315	8-6601-2-BK.....	301	9-2104-1-322.....	11, 273
8-1780-2-79.....	315	8-6601-3-11.....	301	9-2134-2-67.....	173, 262
8-1780-3-111.....	315	8-6601-3-BK.....	301	9-2204-2-322.....	33, 272
8-1780-3-79.....	315	8-6601-4-11.....	301	9-2262-1-79.....	275
8-1909-2-66.....	305	8-6601-4-BK.....	301	9-2302-1-260.....	272
8-1909-3-66.....	305	8-6901-2-322.....	281	9-256-1-307.....	273
8-1909-4-66.....	305	8-6901-3-322.....	281	9-3045-1-13.....	49
8-1972-2-322.....	302	8-6901-4-322.....	281	9-3164-2-322.....	23, 271
8-1972-3-322.....	302	8-880-2-109.....	303	9-400-1-11.....	259
8-1972-4-322.....	302	8-880-3-109.....	303	9-400-1-121.....	259
8-1977-2-143.....	290	8-880-4-109.....	303	9-4364-1-322.....	29, 272
8-1977-3-143.....	290	8-9702-4-322.....	279	9-4417-1-322.....	40, 283
8-1977-4-143.....	290	8-9702-6-322.....	279	9-4484-2-89.....	88, 271
8-2069-2-51.....	294	8-9702-8-322.....	279	9-5005-1-79.....	274
8-2069-3-51.....	294	8-993-3-41.....	314	9-5531-2-143.....	168
8-2069-4-51.....	294	8-993-4-41.....	314	9-5531-2-143.....	273
8-2148-2-109.....	310	8-993-6-41.....	314	9-5950-2-25.....	276
8-2148-3-109.....	310	9-0159-2-76.....	276	9-6054-1-13.....	262
8-2148-4-109.....	310	9-100-1-109.....	263	9-6074-1-90.....	377
8-2149-2-11.....	311	9-100-1-44.....	263	9-6080-1-143.....	293
8-2149-3-11.....	311	9-1638-1-143.....	275, 289	9-6624-1-89.....	87, 271
8-2149-4-11.....	311	9-1645-1-143.....	260	9-6696-2-143.....	271
8-2154-2-67.....	309	9-1645-1-173.....	260	9-8073-2-51.....	129, 275
8-2154-3-67.....	309	9-1648-1-89.....	277, 295	9-880-1-109.....	303
8-2154-4-67.....	309	9-1649-1-89.....	277, 295	9-8812-2-92.....	177
8-3600-2-322.....	287	9-1665CP-1-322.....	266	9-8884-1-172.....	269
8-3600-3-322.....	287	9-1665CP-1-89.....	266	9-8884-1-173.....	269
8-3600-4-322.....	287	9-1686-1-142.....	268	9-8884-1-174.....	269
8-4417-2-322.....	283	9-1686-1-143.....	268	9-8884-1-175.....	269
8-4417-3-322.....	283	9-1686-1-175.....	268	9-9004-1-88.....	276
8-4417-4-322.....	283	9-1697-1-143.....	101, 274	9-9004-2-88.....	276
8-4508-2-SN.....	308	9-1710-2-13.....	50, 277	9-9065-1-95.....	274
8-4508-3-SN.....	308	9-1750-1-89.....	277	9-9157-1-51.....	275
8-4508-4-SN.....	308	9-1792-15-89.....	170, 273	9-9342-1-162.....	325
8-530-2-322.....	297	9-1826-1-320.....	145	9-9343-2-162.....	325
8-530-2-BK.....	297	9-183-2-171.....	156, 272	9-9702-2-322.....	272, 279
8-530-4-322.....	297	9-1888-1-143.....	275	9-9944-1-143.....	34, 273
8-530-4-BK.....	297	9-1902-1-13.....	261		
8-560-2-11.....	306	9-1902-1-322.....	261		
8-560-2-BK.....	306	9-1905-2-143.....	114, 275		
8-560-3-11.....	306	9-1924-1-261.....	124, 274		
8-560-3-BK.....	306	9-1940-2-89.....	85, 273		





3130 North Berkeley Lake Road NW | Duluth, GA 30096
TEL 800 801 1621 TEL 404 890 7540 FAX 877 547 2869

SAVOYHOUSE.COM

MLXV